

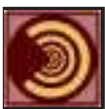

1

HISTORY AND APPRECIATION OF ART (FROM 3000 BC TO 600 AD)

From Indus Valley Civilization (2500 BC-1750BC) to Mauryan dynasty (Third century B.C.), we see a gradual development in art and crafts. Artists of the Harappan period were extremely skilled. Mauryan period marked a new beginning in Indian history. Highly polished quality of the sculpted pillars from the Ashokan period are treasure of Indian art. Alongwith this technically improved style, there was also the tradition of popular folk art, which continued in the form of crude mother goddess figures. After the Mauryans, when the Sungas came to power, they continued with the artistic activity and we got the great **Stupa** and **sculptures** of **Sanchi** in the state of Madhya Pradesh. The Kushans, who had come from outside India, helped in the progress. During this period, we see the development of the sculpted portraiture for the first time. Gupta period is regarded as the golden period in Indian Art History. Refinement came in the representation of the human figures. Some of the most important art centres during this period were **Mathura**, **Sarnath**, **Ujjain**, **Ahichhatra** and others. Gupta sculptures show the perfect balance and blending of the style, the skill, the mastery and the imagination. The religious sculptures show a divine quality. The slight tilt of the lip, the full roundness of the figures, accurate carvings and simplicity became the stylistic stamp of the Guptas. Along with the religious, secular sculptures were also produced in a large extent. Famous paintings of **Ajanta** were done during this period. Beside paintings and sculptures, the new development in art was the **Cave** and **Temple** architectures. Some of the important sites in this respect are the **Udaygiri** caves in Madhya Pradesh and the Nachna and Bhumara, where temple architectures started. In a nutshell it can be said that *Gupta period is classical period of the Indian history.*



OBJECTIVES

After studying this lesson, the learner will be able to:

- describe in brief the art of this period from 3000 BC to 600 AD;

MODULE - 1

*Introduction of
Indian Art*



Notes

History and Appreciation of Art (From 3000 BC to 600 AD)



DANCING GIRL

- state the names of enlisted art objects of this period;
- distinguish the materials used, sites, sizes, colours and place of collection of the enlisted art objects;
- identify distinctly the names of enlisted art objects of this period; and
- differentiate and identify the characteristics of the enlisted art objects.

1.1 DANCING GIRL

Title	:	Dancing Girl
Medium	:	Metal
Date	:	Harappan Period (2500 BC)
Finding site	:	Mohenjo – Daro
Size	:	4 inches (Approx)
Artist	:	Unknown
Collection	:	National Museum, New Delhi

GENERAL DESCRIPTION

This statue is made of metal and is probably one of the finest examples of the artistic and technical skills of Indus Valley craftsmen. This female figure at the same time shows the fine skills of metal casting and artistic refinery. The figure is lanky, thin and rhythmic in character. Some very interesting points can be noticed in sculpture. First of all, while she has been shown without clothes, in her left hand she has bangles till almost her shoulder, very much like we can find in the tribal people of modern days in Gujarat and Rajasthan region. Second important thing to notice is the hairstyle. While the other mother goddess figures, which have been found from this civilization, have a queer and elaborate hair style. This figure shows a much contemporary style. Her hair is tied in a bun. Also to be noticed is its curious posture. She stands in a resting posture with her right hand at her waist and her left hand on her left thigh. The casting is perfect. It shows accuracy of the artists in metal casting during that period. There is tremendous monumentality in this particular sculpture. That means, though this is approximately 4 inches in height only, it seems to be a larger one to us. This is what makes it really unique. The craftsmanship and artistic skills have been blended successfully in Dancing Girl.



INTEXT QUESTIONS 1.1

- From where have we found the Dancing Girl sculpture?
- What is its height?
- Is the Dancing Girl standing or sitting?



MODULE - 1

*Introduction of
Indian Art*



Notes

History and Appreciation of Art (From 3000 BC to 600 AD)



A. Bull capital from Rampurva,
Third century B.C.
Polished sandstone.
Calcutta, Indian Museum

RAMPURVA BULL CAPITAL

- d) What is the dress of the Dancing Girl?
- e) What is the medium of this sculpture?
- f) What is the hairstyle of the Dancing Girl?

1.2 RAMPURVA BULL CAPITAL

Title	: Rampurva Bull Capital
Medium	: Polished sandstone
Date	: Mauryan Period (3 rd century BC)
Finding Site	: Rampurva
Size	: 7 ft (Approx)
Artist	: Unknown
Collection	: Indian Museum, Kolkata

GENERAL DESCRIPTION

Emperor Ashoka engraved his edicts and teachings of Lord Buddha on pillars, rock surfaces and tablets. Ashokan pillars have been found in almost every region of India except extreme southern region. His pillars consisted of three parts – a base, an elongated shaft, and the decorated crown of the pillar, called the Capital. Capitals are mostly consisted of one or more animal figures, an inverted lotus, which serves as the base of these animal figures. A thick disc kind of structure known as abacus is between the animals and the lotus. Bull Capital is one of the most famous ones among the Ashokan capitals. It is also known as Rampurva Bull Capital, after the name of the place from where this is found. This particular one is comprised of a bell shaped inverted lotus as the base, the abacus and on the top the animal part – a majestic bull. There are plant designs around the abacus. Scholars are of opinion that these motifs had either come from earlier Middle East or Post Greek Style. The designs are very minutely and accurately carved. The figure of the Bull dominates over the lotus and the abacus. Though the part of the stone in between the four legs is not carved out, it doesn't disturb the strength or beauty of the bull. We can feel the weight and the power of the animal and there lies the success of the artist. In fact the ornate quality of the lotus base and the abacus create a contrast with the plain representation of the bull. The carving of the Bull obviously shows mastery of the Indian sculptor over their subjects. What is unique about this Bull Capital, is its extremely polished quality. This is one of the most important characteristics of the Mauryan sculptures from Ashokan period. According to the scholars, the technique of high polish was learnt from the sculptors of Middle East.



INTEXT QUESTIONS 1.2

- a) From where was this Bull Capital found?



MODULE - 1

*Introduction of
Indian Art*



Notes

History and Appreciation of Art (From 3000 BC to 600 AD)



BLACK PRINCESS

- b) What serves as the base of the Bull Capital?
- c) What is there on the abacus of the Bull Capital?
- d) Where is this Bull Capital now?
- e) What is the material of this Bull Capital?

1.3 BLACK PRINCESS

Title	:	Black Princess
Medium	:	Wall Painting (mural)
Date	:	Gupta Vakataka Period (2 nd century AD to 6 th century AD)
Finding Site	:	Ajanta
Size	:	20 ft x 6 ft (Approx)
Artist	:	Unknown

GENERAL DESCRIPTION

The caves of Ajanta are situated near Aurangabad district in Maharashtra. The caves are named after the nearby village Ajintha. The caves, including the unfinished one, are thirty in number. Some of the caves served as the **Chaityas** (worshipping places) and most of them were **Viharas** (Monasteries). Ajanta paintings were done in two phases – first, the **Hinayana phase** (where Lord Buddha is represented in symbols) and the second, the **Mahayana phase** (where he is shown in human form). Most of the Ajanta paintings were done in the **Vakataka Period**. Ajanta paintings occupy a unique position in the history of Indian painting. Ajanta paintings are not done in Fresco. Fresco is a technique, where colours are mixed with water soluble binders and painted on either dry or wet plaster. But Ajanta artists have **used traditional technique of tempera**. The themes of Ajanta paintings were primarily religious in nature. But at the same time they also gave enough scope to the artists to show their creative and imaginative skills. The best part is that, even being religious paintings, they can be enjoyed by common people. Black Princess is, no doubt, one of the best examples of the Ajanta paintings. The free flowing line, subtle rhythm of the body contour, the slight tilt of the face and the curves of the eyes, all show the mastery of the artist and his control over the brush. Even the damaged painting gives a clear picture of how beautiful the colours were. There is a lyrical quality in the painting. The softness of the body contour, subtle bending of the neck and the simplicity give an heavenly quality to the painting. The colours used have been very earthly and devoid of any loudness.

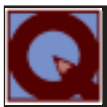

INTEXT QUESTIONS 1.3

- (a) Where do we find the Ajanta caves?





- (b) In which phase was Lord Buddha shown in symbolic way?
- (c) What is the type of colours used in the Black Princess?
- (d) In which phase of Ajanta painting Black Princess was done?
- (e) What is the time period of Black Princess?



WHAT YOU HAVE LEARNT

Indus Valley Civilization was named after the site from where the first evidence of this civilization was found. Main sites of this civilization are **Mohenjo-daro** and **Harappa** (now in Pakistan). Though initially it was considered that this civilization was mainly concentrated in the Indus River Valley and was named accordingly, recent excavations show that it was extended beyond the basin of River Indus. This civilization is also known as Harappan Civilization and is believed to have flourished between 2500 B.C. and 1750 B.C. Great numbers of art and antiquities have been found from this period, which include seals, potteries, jewellery, tools, toys and statuettes and other utilitarian objects.

The next important period in Indian history was the time of the **Mauryan Dynasty**, which was founded by **Chandragupta Maurya**. Though he himself is an illustrious figure in Indian history, mainly because of his administration and his minister **Kautilya**, better known as **Chanakya**, his grandson **Ashoka the Great** did lots of benevolent works and contributed much to the development of art and architecture. He was a follower of Buddhism and erected pillars all over the empire to spread the teachings of Lord Buddha.

The Mauryan period was followed by the rules of dynasties like **Sungas**, **Satavahanas** and **Kushans**. **Kushans** had come from outside India but contributed a lot in the development of Indian art and architecture.

The Gupta dynasty, founded by **Chandragupta I**, succeeded the **Kushanas**. **Guptas** were not only great warriors and administrators, but they were also great patrons of different types of arts. Under the imperial of Guptas there occurred an overall development in every field, including all kinds of art and science. This period saw the rise of the legendary personalities like **Kalidasa**, **Aryabhatta** and **Varahamihira**. It is justified to call Gupta Period as the **Golden period of Indian History** in all respects.



TERMINAL EXERCISES

1. Write in short about the works of Indus Valley Civilization.
2. Describe in brief the posture of the Dancing Girl.

3. Write in short about Mauryan art.
4. Why do we call Gupta period as the golden or the classical period of Indian history?
5. What are the specialities of the Mauryan sculptures?
6. What was the contribution of the Kushans?
7. What were the characteristics of the Gupta period paintings?



ANSWERS TO INTEXT QUESTIONS

1.1

- a) Mohenjo – daro
- b) 4 inches (Approx)
- c) Standing
- d) She is without clothes
- e) Metal
- f) It is tied in a bun

1.2

- a) Rampurva
- b) Inverted bell shaped lotus
- c) Plant motif
- d) Indian Museum
- e) Polished Stone

1.3

- a) Near Aurangabad in Maharashtra
- b) Hinayana Phase
- c) Earth colours
- d) Mahayana Phase
- e) 2nd – 6th c A.D. Gupta Vakataka period



**Notes****GLOSSARY/TERMINOLOGY**

Statuettes	–	Small statues
Utilitarian	–	Anything with a utility purpose
Lanky	–	Thin and tall
Shaft	–	Narrow and usually vertical space
Edicts	–	Order proclaimed by authority
Frescos	–	Kind of painting done on wet walls
Portrait	–	Drawing, painting, photograph of a person
Stupa	–	Memorial on mortal remains of Saint and Worshipping place for Buddhists
Tempera	–	Water colour mixed with white.
Materealistic World	–	Common general world opposite spiritual world.
Lyrical	–	Poem like



2

HISTORY AND APPRECIATION OF ART FROM 7th AD TO 12th AD

The Post Gupta period in India is known for the progress in temple architecture and sculpture. Major dynasties like, **Pallavas, Cholas, Hoysalas** in the south and **Palas, Senas, and Gangas** in the east patronized this progress. In the south, in Mahabalipuram or Mamallapuram, we see the **Pancharathas** and the **Mandapa** structures. While **Pallavas** and their rivals, Western **Chalukyans** are remembered for their sculptural activities, **Cholas** and **Hoysalas** would be always remembered for their temple projects. **Chola** artists excelled in the techniques of bronze casting and intricate metal sculptures with delicate and rhythmic body movements. But at the same time **Chola** period has also given us some of the most important temples of Southern India – like the **Gangakondacholapuram** temple, **Brihadeswar** temple and others. These temples are important for their simplicity, monumentality and majestic quality. Next in importance was **Hoysala** art. **Hoysala** style was a mix of intricate design and detail study. During the rule of the **Hoysala** kings, many important temple projects were given shape. Speciality of the **Hoysala** period temples are the presence of temple sculptures as part of the architecture. **They form an important part of the architecture.** In the eastern part of the country, some of the temple projects were taken up by the **Ganga** rulers, like the **Mukteswar** temple, **Lingaraja** temple and **Rajarani** temple in Orissa. Some of the most important Indian temples of **Kanchipuram, Chennai, Bhubaneshwar, Bankura, Belur** and **Halebid** were built during this time. Artists by this time had become more and more proficient in carving and other techniques. Hence, this particular time is very important to understand the development of the Indian art and architecture.

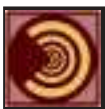

OBJECTIVES

After studying this lesson, the learner will be able to:

- describe in brief the art of the period from 7th century AD to 12th century AD;



ARJUNA'S PENANCE OR GANGAVATARANA

- identify the art objects of this period;
- distinguish between enlisted art objects of this period;
- mention the main characteristics of the enlisted art objects of this period; and
- identify distinctly the names of enlisted art objects of this period.

2.1 ARJUNA'S PENANCE OR GANGAVATARANA

Title	:	Arjuna's Penance or Gangavatarana
Medium	:	Stone
Date	:	Pallava Period (7th century AD)
Finding Site	:	Mamallapuram (Chennai)
Size	:	91 ft X 152 ft (Approx)
Artist	:	Unknown

GENERAL DESCRIPTION

The monuments of the **Pallavas** consist of cave temples and structural temples, plus a few monolithic structures. One of the most important sculptural works of this period is from **Mamallapuram**. The relief is on two huge boulders. The sculpture is uneven but very distinct and spontaneous in representation. There is a flow in the whole composition. There is a crowd of life-size human and animal figures. They include gods, demi-gods, and sages, all in the flying position. There is a cleft in between the two boulders. All the figures are shown facing the cleft. Though there are lots of movements and energy on the upper part of the relief, in the lower part of the composition the life shown almost calms down. The ascetic figures in the crowd have been shown in meditating posture. The name of the relief, according to some scholars, is **Gangavatarana** where **Shiva** has been shown receiving the flow of Ganges in his hair. To the right of the cleft a four-armed figure larger than all the rest can be identified as **Shiva** by the trident over his shoulders and his group of followers. Others think that it should be known as **Arjuna's Penance**, because a male figure (which they think is Arjuna) has been shown at one end in the posture of meditation. This is a distinctly Pallava Period work. There is enormous speed and monumentality in the sculptures. The animal figures and their characterization show the close observation of the artists. For example, the sleeping baby elephant, the monkey figures, the deer scratching its nose, all show their acute study of the natural world. The figures have softness in the treatment and roundness. This has been regarded for ages as one of the masterpieces of the Indian sculptures from the southern part of the country.

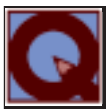

INTEXT QUESTIONS 2.1

- Where is Arjuna's Penance located?
- Arjuna's Penance was built under which dynasty?



MODULE - 1

*Introduction of
Indian Art*



Notes

History and Appreciation of Art (From 7th AD to 12th AD)



KRISHNA SUPPORTING MOUNT
GOVARDHANA

- c) What is the other name of Arjuna's Penance?
 d) What is the measurement of the sculptural relief?

2.2 KRISHNA SUPPORTING MOUNT GOVARDHANA

Title	:	Krishna Supporting Mount Govardhana
Medium	:	Stone
Date	:	Hoysala Period
Finding Site	:	Belur
Size	:	3 ft
Artist	:	Unknown

GENERAL DESCRIPTION

Temple architectures were one of the important activities during **Hoysala period**. Besides the elaborate temple architectures, each temple of this period was decorated with sculptures, which formed an intrinsic part of the architecture. The **Hoysala** style is named after one of the famous dynasties of the **Deccan**, which emerged around the middle of the eleventh century and is generally considered to have come to an end in the mid fourteenth century. The capital of the **Hoysala** kings was **Dvarasamudra**, the modern **Halebid**. Hoysala style is unique in its own way and is highly characterized. The earliest major **Hoysala** temples are at **Belur**. Hoysala sculptures show deep carving and undercutting, soft rhythms of the body contours, delicate and intricate designs. Deep carving and undercutting is facilitated by the soft stone. It gives the rich surface texture and is responsible for the intricate and detail scenes. This **Krishna Sculpture** is one of the best examples of the delicate and intricate **Hoysala** carving. The whole incident has been shown in layers. The obvious placement of **Krishna** as the central figure with human beings and cattle in different layers present an interesting way of narration. Though **Krishna** has been shown in a heroic form, his stance of standing and the rhythmic limbs bring softness in the whole composition. Very interesting to notice is the liveliness of the animal figures. With heavy breasts and buttocks, elaborate jewellerys, typical Indian hair-style, this composition is an example of typical **Hoysala period style**, where the intricate carvings of the stone shows the mastery of the artist.

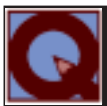

INTEXT QUESTIONS 2.2

- a) Name one temple site of the Hoysala period.
 b) Name the earlier name of Halebid.



MODULE - 1

*Introduction of
Indian Art*



Notes

History and Appreciation of Art (From 7th AD to 12th AD)



SURASUNDARI FROM KONARK

- c) When did Hoysala kings become powerful?
- d) Where was the Hoysala kingdom?
- e) From where the given example of sculpture has been found?

2.3 SURASUNDARI FROM KONARKA

Title	: Surasundari from Konarka
Medium	: Stone
Date	: Ganga Dynasty (12 th century AD)
Finding Site	: Konarka, Orissa
Size	: Little more than life size
Artist	: Unknown

GENERAL DESCRIPTION

The **Sun Temple at Konarka**, one of the best of great Orissan architectures was built by **King Narsimhadeva I** of the **Ganga dynasty** in the eastern coast of India near Puri in Orissa. The period saw a different type of sculptural development. The temple is famous for its gigantic structure and larger than life size sculptures. The larger images, usually of black stone have a little bit of affinity with later Bengal style of the **Pala** period. The modelling is tight and the face is broad with smile. The works are robust and have loose plasticity. The sculpture of the temple increases beauty and aesthetic value of the temple. The large Sun image and the female musician figures present a different kind of quality in this temple. This little more than life size female musician is one from the group of similar kind of sculptures. These female musician groups are found on the terraces above the bottom and the middle tiers. They have been shown playing with full confidence and delight. They are boldly carved. The figures are full of movement and volume. Each one is shown with a different kind of musical instruments. The **Surasundary** is shown with a drum. In spite of the big face with smile, the rhythmic actions of the limbs and the slight tilt of the head, present the graceful beauty of this drummer. The soft carving of the ornaments in between the breasts enhance the softness of the figure. The bends and the curves of the figures present a rhythm. The folds of the draperies and the posture add to the rhythm of the figure.

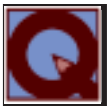

INTEXT QUESTIONS 2.3

- a) What is this Surasundari figure has been shown playing?
- b) Who built the Sun temple of Konarka?

MODULE - 1

Introduction of Indian Art



Notes



Notes

- c) Where is the Sun temple of Konarka situated?
- d) What is the sculpture made of?
- e) Which dynasty did Konarka belong to?



WHAT YOU HAVE LEARNT

After the golden period of the Gupta dynasty, the development in the field of art and architecture continued under different dynasties. In the post Gupta period, the centres of the art activities shifted to southern and eastern India. In the 7th century AD Pallavas became powerful. Their capital was **Mamallapuram** or **Mahabalipuram**.

The main centres, which flourished during this period, were **Mamallapuram** and **Kanchipuram**. Hence a major portion of art works of this period are found in these centres. Some of the important contributions of the **Pallavas** in the field of Art are seen at **Mahabalipuram**. These are **Pancharathas**, **Arjuna's Penance**, **Mandapas**, the relief sculptures and many more. After the **Pallavas**, the important Southern dynasties were **Chalukyas**, **Cholas** and **Hoysalas**. **Pallava**, **Chalukyan**, and **Chola** sculptures show a gentleness, which was not seen before. While the Cholas excelled in the technique of bronze sculptures, **Hoysala** period is remembered for the stone sculptures with intricate works. They are known for their subtle poses, rhythms and movements in their works. Some of the best temple architectures were also built during their time, like **Haysaleswara** temple at **Halebid**, **Kesava** temple of **Somnathpur**. After the **Palas** and **Senas**, the dynasty that became prominent was the **Ganga** dynasty in the east. This dynasty is remembered as an important builder and is credited with the construction of the gorgeous and majestic **Sun temple** of **Konarka** in Orissa. The temple, which is in the form of a chariot drawn by horses, is world famous for its architecture and sculptures. Though the architecture is damaged badly, what remains is enough for us to understand the greatness of the artists of this period.



TERMINAL EXERCISES

1. Write in brief about the relief of Arjuna's Penance. Where is it located?
2. Where is the Sun temple of Konarka? Write in brief about it.
3. What are the characteristics of the Konarka sculptures?
4. Write in brief about the particular example of Krishna Govardhana sculpture from the Hoysala period.
5. Write the main characteristics of Hoysala period sculptures.
6. Write in short about the Konarka Sun temple.



ANSWERS TO INTEXT QUESTIONS

2.1

- a) Mahabalipuram or Mamallapuram
- b) Pallava dynasty
- c) Gangavatarana (Descent of Ganga)
- d) 91 ft X 152.ft (Approx)

2.2

- a) Belur:
- b) Dvarasamudra
- c) 11th Century;
- d) Deccan
- e) Belur

2.3

- a) Drum
- b) Narasimhadeva 1
- c) Orissa
- d) Stone
- e) Ganga Dynasty

GLOSSARY

Plasticity	- Softness
Tilt	- Slight bend
Undercutting	- Cuts in the deeper layers in a sculpture
Contours	- Boundary line
Schist	- One kind of stone
Cleft	- Gap
Meditating	- Worshipping
Monumentality	- Hugeness felt inspite of smaller scale

MODULE - 1

*Introduction of
Indian Art*



Notes

MODULE - 1

History and Appreciation of Art (From 7th AD to 12th AD)

Introduction of Indian Art



Notes

- Characterization - Creation and convincing representation
- Penance - Meditation
- Draperies - Cloth, Fabric
- Subtle - Delicate
- Chariot - Two-wheeled vehicle



3

HISTORY AND APPRECIATION OF ART FROM 13th CENTURY AD TO 18th CENTURY AD

After the decline of the powerful ruling dynasties in different parts of India, there were hardly any patrons to support a large scale project of art during 12th Century A.D. except few constructions of temples in Rajasthan, Bengal and Orissa. It was mainly restricted to building forts and Maqbaras by the Muslim rulers who did not patronise sculptural art, but this period enriched Indian art with treasure of illustrated manuscripts. The manuscripts of this period belonged to different religious sects like Hindus, Jains and Buddhists. The main centres of these illustrated manuscripts (Punthis) were in Bengal, Gujarat and Bihar. The manuscripts were made in Bengal and Bihar under the patronage of **Pala** dynasty and it shows a distinct style called “**Pala style**”. On the other hand Jain religious manuscripts were written and illustrated in Gujarat. These “**Punthis**” or manuscripts are done on palm leaf. The scripts are written in beautiful calligraphic art leaving some space for illustration.

Temple architecture was also developed in some parts of India in this period. Among these, the marble temple complex of **Dilwara** at **Mount Abu** and terracotta temples of Bengal and Orissa are very beautiful.

Rajput paintings and Mughal paintings flourished from the 16th Century A.D. to 19th Century A.D. The Rajput paintings were combination of folk paintings and Ajanta paintings while Mughal paintings were combination of Persian and Rajput painting. After the 18th Century, Indian art started to decline.



OBJECTIVES

After studying this lesson, the learner will be able to:-

- describe the art scene of India during 12th Century A.D. to 18th Century A.D;

MODULE - 1

Introduction of Indian Art



Notes

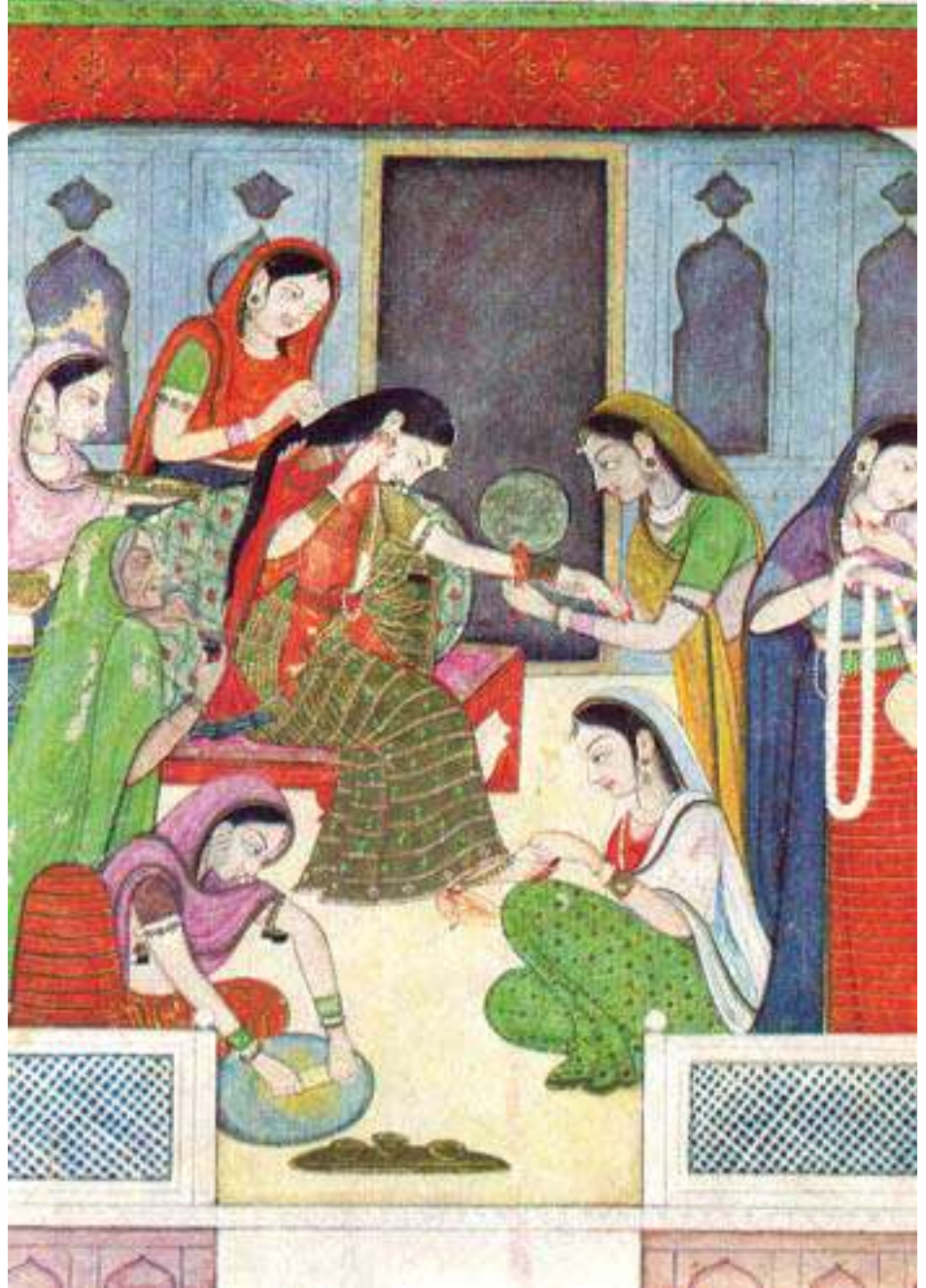

SRINGAR

- write the reasons for the decline of Indian art;
- explain the manuscript illustration of this period;
- describe one of the most important Rajput schools of paintings;
- write on terracotta and terracotta temples.

3.1 SRINGAR

TITLE – SRINGAR

Style – Guler school

Period – 18th Century A.D.

Artist – unknown

Medium – Tempera

Guler was a small state near **Kangra valley** and one of the most important centres of the **Pahari School of paintings**. This style flourished between 1450 A.D. to 1780 A.D. under the different rulers of this kingdom. **Guler miniature** went through different stages of development under the influence of Folk art to **Mughal miniature** style. **The Guler painting** reached its maturity in the 18th Century A.D. According to some scholars, the **Pahari School** had its origin in **Guler** which influenced many other **Pahari Schools like Kangra**. Guler paintings are characterised by genuine romanticism of the myth of **Krishna** and **Radha** which is still a living symbol of divine love. Stories of **Ramayana** and **Mahabharata** were also used as the themes of **Guler** paintings along with royal portraits and court scenes. The painting “**Sringar**” is a typical **Rajput painting** with such a theme.

A bride is being adorned for her wedding. The figures are placed in perfect harmony and balance against an architectural setting. A maid is preparing sandal paste in the foreground. Another woman is tying an anklet on the foot of the bride. There are two standing figures. One is holding a mirror and other one is making a garland of flowers. A lady is busy in combing the brides' hair with an assistant. An elderly woman is supervising the whole procedure.

The painter's mastery in infusing the essence of shyness and elegance in the posture of the bride is noteworthy. The exquisite faces, graceful attitudes and soft harmony of colours are characteristics of **Guler school**.



INTEXT QUESTIONS 3.1

1. Name the places of origin of **Pahari painting**.

MODULE - 1

Introduction of Indian Art



Notes

MODULE - 1

Introduction of Indian Art



Notes

History and Appreciation of Art From 12th Century AD to.....

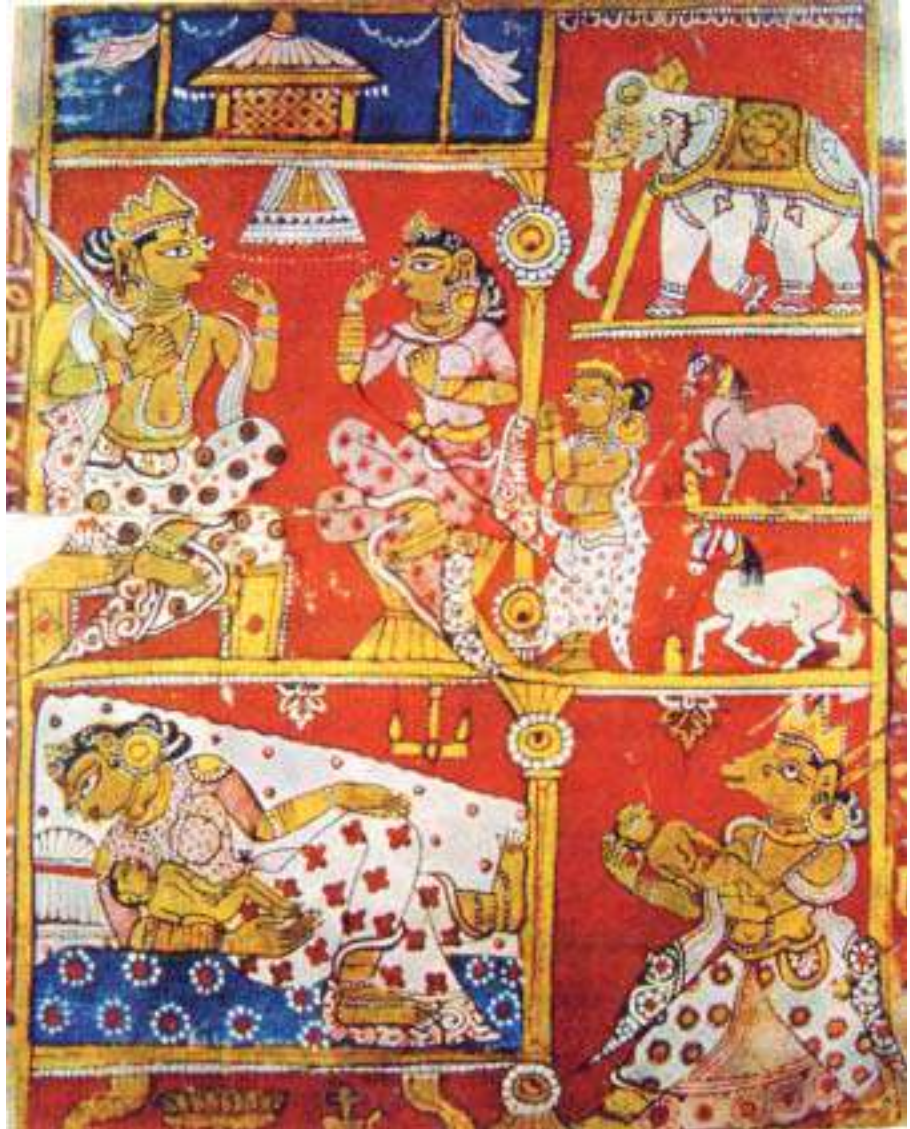

JAIN MINIATURE

2. What is most favourite themes of **Guler painting** ?
3. What are the two figures in the foreground of painting **Sringar** doing ?
4. Write one characteristic of **Guler School**.

3.2 JAIN MINIATURE

- Title – **Kalpasutra**
- Artist – unknown
- Style – Jain Manuscript painting
- Period – 15th Century A.D.
- Medium – Tempera on palm leaf.

Jain miniature paintings were developed all over India from 7th Century A.D. and reached its maturity during 10th Century A.D. and 15th Century A.D. Jain scriptures like “**Kalkacharya Katha**” and “**Kalpasutra**” are illustrated with images of **Tirthankaras** like **Parsvnath, Neminath, Rishabhath** and others.

Most of the Jain miniatures were done during 10th Century A.D. The important centres of these paintings were Punjab, Bengal, Orissa, Gujarat and Rajasthan.

These manuscripts are mainly made of palm leaf. So the paintings are also done on it along with the scripts. The colours are made from locally available pigments. Red and yellow are the most predominant shades along with gold and silver colours. The human figures show some special characteristics in these paintings. The faces are in profile showing both the eyes in frontal view. Thus one of the eyes has gone beyond the outline of the face. The torsoes of the figures are also in frontal pose. Interestingly female figures show lot of ornaments and jewelleryes on them. Lines are given almost emphasis in these paintings.

Here is a painting from “**Kalpasutra**”, a Jain book of rituals. The composition of this painting space is divided into few squares and rectangles. The figures of men, women and animals are set against red background. Each segment of format is outlined with yellow colour. Each segment narrates different sequence of story of **Kalpasutra**. The gold and ultramarine are derived from gemstones. The style is full of folk elements like flatness of the form, stereotyped expression and lack of perspective. In spite of that the artist's observation of architectural patterns and textile design is very interesting.

The fluent lines for contour and use of decorative dots enhance the beauty of this painting.



MODULE - 1

*Introduction of
Indian Art*



Notes

History and Appreciation of Art From 12th Century AD to.....

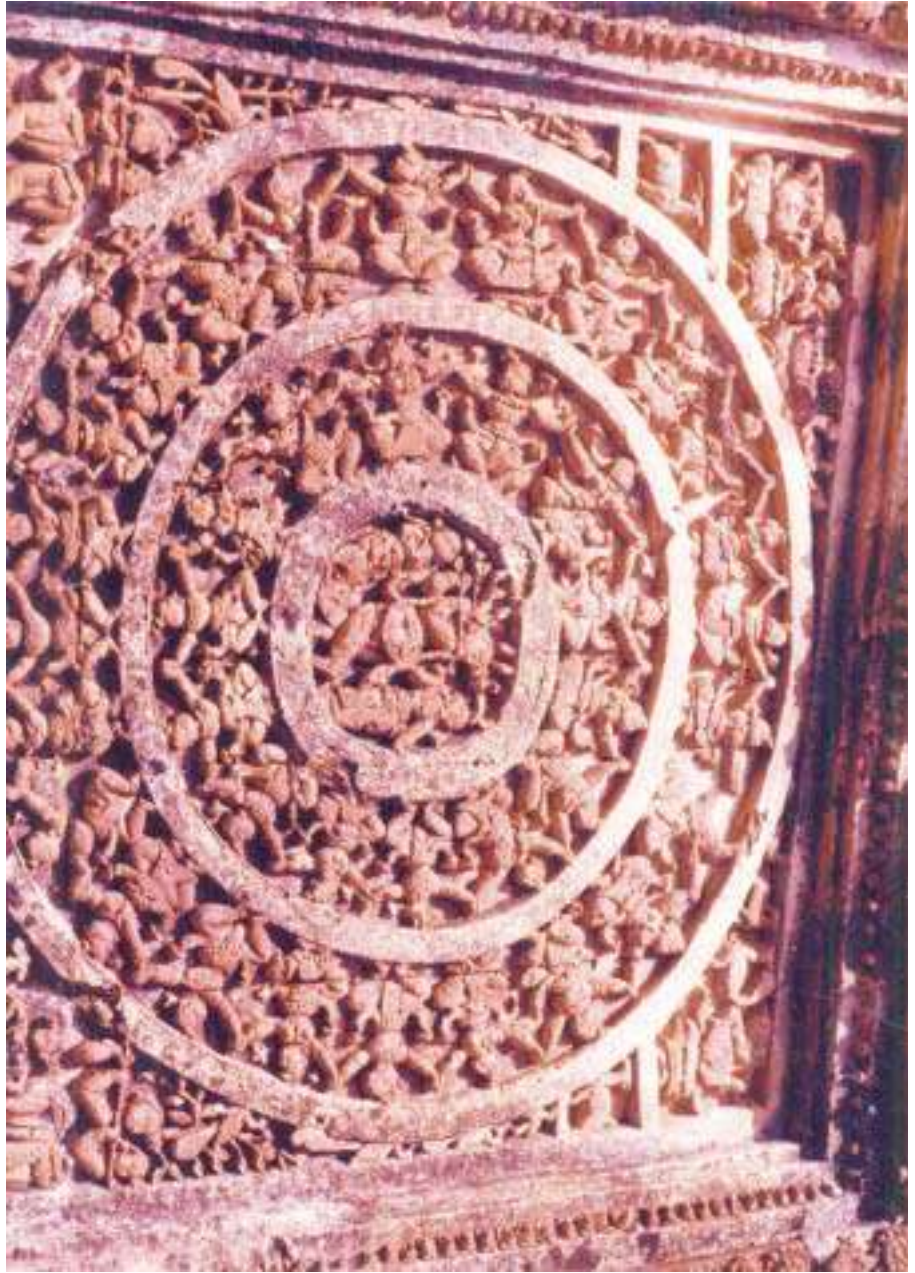

RASLILA



INTEXT QUESTIONS 3.2

1. When did **Jain miniature paintings** develop?
2. What are the illustrations in **Jain miniatures**?
3. Name the predominant colours in a **Jain miniature painting**.
4. What are the special characters of human figures in these paintings?

3.3 RASLILA

- Title – **Bishnupur Terracottas**.
- Artist – unknown
- Site – Panchmura Temple, Bishnupur, West Bengal
- Period – Around 17th Century A.D.
- Medium – Terracotta Tiles

Bishnupur is a small town in west Bengal. Once it was the capital of the Kingdom in the Bankura district. There are many small temples which are decorated with terracotta tiles. This terracotta art reflects various cultural and religious currents of 18th and 19th Century A.D. Most of the temples are dedicated either to **Shiva** or **Vishnu**. The theme of these terracotta tiles reflect divergent religious traditions. Figures of **Shiva - Durga** and **Radha - Krishna** are seen along with characters from **Ramayana** and **Mahabharata**.

The artist took keen interest to depict the contemporary social life as well. They represent various subjects relating to human, animal and bird life.

The temple architecture is based on the design of Bengali thatched hut type in single or double storeys. The walls are decorated with small pieces of terracotta tiles by sticking them on the wall with mortar. These clay tiles are made from mould almost like clay bricks. These are burnt to make it permanent in the form of terracotta.

Raslila is a celebration of divine love of **Radha** and **Krishna** with their friends **Gopis** and **Gopiyan**. This beautiful panel is composed of three concentric circles within a square space. The middle circle is occupied by the figures of **Radha Krishna** along with a **Gopi**, other two circles show rows of figures holding each other's hands. The four corners of the square are decorated with human figures, animal figures and birds.



INTEXT QUESTIONS 3.3

1. Where is **Bishnupur**?



Notes

MODULE - 1

Introduction of Indian Art



Notes

History and Appreciation of Art From 12th Century AD to.....

2. How are the temples of **Bishnupur** decorated?
3. What do the figures show in these works of terracotta?
4. Mention the period of development of this style.



WHAT YOU HAVE LEARNT

Lack of patrons definitely affects the growth of art, but it cannot diminish the creativity in an artist. The art scene in India from 12th Century A.D. to 18th Century A.D. proves this. There were lots of changes in the art style of this period. Paintings became small in size like the **Jain, Buddhist and Hindu illustrated manuscripts**. The **Rajput and Mughal** paintings are also small in format. In spite of its reduced size, the aesthetic and technical quality are of very high standard.

Besides miniature paintings, relief works in terracotta became very popular in the eastern part of India, particularly in West Bengal. Many temples were decorated with these tiles.



TERMINAL EXERCISE

1. Trace the development of art after 12th Century A.D. in India.
2. What is terracotta? Describe a temple which is embellished with terracotta tiles.
3. Write a note on a selected school of miniature painting of India.
4. What are the main characteristics of **Jain miniature painting**?



ANSWERS TO INTEXT QUESTIONS

- 3.1**
1. (c) Guler
 2. (a) Radhakrishna (c) Ramayana
 3. (b) Tying the anklet and Pasting sandalwood
 4. The exquisite forces, graceful attitudes.
- 3.2**
1. 7th C.A.D., during 10th C.A.D. to 15th C.A.D.
 2. Images of **Tirthankaras** like **Parshavanath, Neminath, Rishabhath** etc.

3. Red, yellow, gold, silver
4. The faces are the profile, eyes in frontal view, one of the eyes go beyond the outline of the face.

- 3.3**
1. West Bengal
 2. Decorated with terracotta tiles
 3. Figures of **Shiva-Durga, Radha-Krishna** and stories of **Ramayana** and **Mahabharata**.
 4. 17th, 18th C.A.D.

GLOSSARY

- **Manuscript** – Books, Documents, etc. are written by hand.
- **Ajanta** – Buddhist caves in Maharashtra. Famous for wall paintings and sculptures dated 2nd Century A.D. to 6th Century A.D.
- **Tempera** – A technique of water colour in which white is mixed.
- **Jain** – A religion preached mainly by **Mahavira** and other **Tirthankaras**.
- **Treasure** – Wealth
- **Calligraphy** – Style of handwriting. Pahari school of painting – Miniature painting

MODULE - 1

Introduction of Indian Art



Notes



FOLK ART OF INDIA

India has inherited a pre-Aryan culture which is reflected in the folk art. Different religions, sects and beliefs have co-existed throughout Indian traditional life. Cults like **Tantra Shakti, Vaishnav, Buddhist** are very important in the life of folk artists. The rural society's needs for art and craft objects are supplied by the local artists and craftsmen which are mainly of three types viz **ritualistic, utilitarian** and **individualistic**.

There are many kinds of ritualistic folk art like **Patachitra, Pichuai, Alpana, Kolam** etc. Decorative wood carving, embroidery, basket work, earthen ware etc. are among the typical utilitarian folk art. These are made by rural artists without any formal training, and most of these designs are repeated by generation after generation. For example, there are hardly any change in the motif of terracotta toys. Those were also made in **Harappa** five thousand years before. Some folk artists attempt to experiment with new forms from time to time and create an individualistic type of folk art. These artists develop a new style within the old format. These innovations are to be found in the motif of **Madhubani** painting, **Kantha** design and **Kalighat Pata Chitra**.



OBJECTIVES

After studying this lesson, the learner will be able to:

- describe the background and region of Folk Art of India;
- identify the different regional folk forms of India;
- explain the medium, techniques and styles of these folk arts;
- state the designs and motifs used in folk art;
- write the names of different kinds of ritualistic folk arts.



Notes



KOLAM



Notes

4.1 KOLAM

Title	–	Floor painting with “Kalas”.
Style	–	Kolam
Artist	–	Unknown house wife
Medium	–	Rice paste and pigments
Period	–	1992
Site	–	A locality near Thanjavur in Tamil Nadu.

GENERAL DESCRIPTION

Floor decoration is one of the most popular forms of art in any culture all over the world. This is also to be found in every part of India in different medium like **Alpana, Rangoli, Kolam, Sanjhi** etc. **Kolam** is the most important part in the cultural and religious festivals of South India. During **Pongal** and other festivals, this decorative art work is done on the floor in front of the house and on the space before the alter of the deity. **Kolam**, like other floor decorative arts of India, is a symbol of fortune. Designs and motifs are traditional in nature and these are both floral and geometrical forms. The floor should be wet or moist by sprinkling water on it. The dry coarse ground rice flour is held between the thumb and forefingers. The hands keep on moving while the rice powder is rubbed to release on the floor along the predetermined design. It is very important to continue the drawing as long as possible without any pause. This fluency of line is achieved by the artist only from experience. Young girls learn this from their mother and grandmother.

Besides the symbolic value of these motifs, it expresses a very interesting meaning of life also. Rice powder is readily available. It seems to feed ants to show one must take care of other forms of life too.

This Kolam is being painted by a house wife. It shows the freehand drawing skill of the artist. There are different symbolic forms like pitchers, lamps and coconut trees. All these are integral parts of Indian rural life. These designs are basically in geometrical format and with very bright colours like Red, Orange, Blue, Yellow and Pink.



INTEXT QUESTIONS 4.1

1. State some of the floor decoration arts of India.
2. What are the designs and motifs used in **Kolam painting**?
3. Write on the method of **Kolam painting**.
4. What are the objects shown in the enlisted **Kolam painting**?



Notes



PHULKARI



Notes

4.2 PHULKARI

Title	–	Chadar
Artist	–	Unknown.
Style	–	Phulkari
Medium	–	Embroidery on cloth with coloured thread.
Period	–	Contemporary.

GENERAL DESCRIPTION

Phulkari actually means “flowered work”. This term is used for a type of embroidery practised by folk women in Punjab. These are done on both small and large cloth pieces and these are used for different purposes like veils to cover heads, garment pieces, chadar and bedspreads or bed covers. The embroidery is worked in floss-silk upon the coarse cotton cloth in darning stitch over counted threads being worked from the back of the fabric.

Basic motifs of **Phulkari** designs is geometric. Squares and triangles are composed all over the space, which are covered with mainly warm colours. There are simple designs and large sized elaborate ones. Squares, dashes, triangles and straight lines and zig-zag lines from endless innovative variation. The predominant colour is the gold of the ripening wheat harvest in Punjab.

The women will first pick up the outline of each section with a needle before it is worked in a direction that contrasts with the section adjacent to it. The combination of contrasting vertical and horizontal stitches results in a beautiful pattern.

The enlisted work of **Phulkari** is designed with traditional geometrical shapes. Star forms are stitched with golden yellow and silvery white thread on red cloth. The basic motif is consisted of a large star surrounded with small stars to create a diamond shaped space on the design. The silken shine of the thread creates bright relief on the warmth of the red surface of the cloth.



INTEXT QUESTIONS 4.2

1. What is the meaning of **Phulkari**?
2. What are the materials used in **Phulkari**?
3. What is the predominant colour in these works?
4. How the pattern of **Phulkari** is achieved?



Notes



KANTHA STITCHING



Notes

4.3 KANTHA STITCHING

Title	–	Kantha from Bengal.
Artist	–	Unknown
Style	–	Kantha Stitching
Medium	–	Embroidery on silk with coloured thread
Period	–	Contemporary.

GENERAL DESCRIPTION

Bengal has a delightful folk tradition of embroidery and quilting known as **Kantha**. The **Kanthas** are made of discarded *sarees* and *dhoties*. These are sewn together to make it thick. **Kanthas** are generally made by the women of all classes in Bengal, particularly the old women. They use their spare time to sew these **Kanthas** by coloured threads from the border of old *sarees* and are stitched along the border line and the surface is filled with various designs. Quilts, wedding mats, bags and wraps for mirror and jewellery were all quilted and embroidered.

Motifs and designs are taken from rural landscapes, ritualistic activities/purposes (mandala), objects from every day life, rural festivals, circus entertainers and even historical figures such as **Queen Victoria** to **Lenin**. The motifs on these **Kanthas** make it clear that the folk women were mostly illiterate but had keen power of observation for day-to-day happenings around them.

The enlisted **Kantha** is a *saree* which is stitched in a typical traditional style and technique. The motifs are stylized forms of animals and human figures. The base pink colour of the *saree* is done in chain stitch with various coloured threads like white, green, purple, red, brown, yellow, grey and black.

A king like figure is sitting on the horse with an umbrella in his hand. Some stylized forms of birds and bees are used as motifs. The influence of **Kalighat Pata Chitra** is very clear on these motifs.

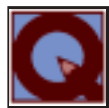

INTEXT QUESTIONS 4.3

1. Name the sources of designs and motifs of **Kantha**.
2. Identify the functional objects on which **Kantha** motifs are stitched.
3. Describe **Kantha saree** in two lines.
4. Which folk art form has influenced the **Kantha motifs**?



TERMINAL EXERCISE

1. What is folk art? How does it help rural society?
2. Describe any one form of floor decoration of folk art style along with its method of preparation.
3. Write a note on **Kantha** stitching.
4. Write in brief about the **Phulkari** style.



WHAT YOU HAVE LEARNT

Folk artists of India beautify the objects of use and the surroundings of their dwellings like floor, wall, courtyard, etc. There are many kinds of folk arts in India, like painting, sculpture, toy, costume, utensils, furniture, etc. Almost every village of India has its own style of folk arts. Among these, some are very popular and well known, for example, **Kalamkari**, **Kolam**, **Madhubani**, **Kalighat**, **Phulkari**, **Kantha** and many more. **Kolam** is floor decoration while **Phulkari** and **Kantha** are embroidery on cloth. **Madhubani**, **Kalighat**, **Kalamkari** are famous for paintings. The artists use the same motifs and designs generation after generation. The **Phulkari** artists use geometrical design. The **Kolam** painters prefer different objects from nature and Bangali women like to use human and animal figures as motif on **Kantha**.



ANSWERS TO INTEXT QUESTIONS

- 4.1**
1. Alpana, Rangoli, Kolam
 2. Geometrical, floral forms
 3. To moist the ground
Rice powder and other colours to be held and rubbed to release on ground.
 4. Pitchers, lamps and coconut trees.
- 4.2**
1. Flowered work
 2. Cloth, floss silk
 3. Golden
 4. Combination of vertical and horizontal stitches.



Notes



- 4.3**
1. Rural landscape, ritualistic activities/purposes (mandala), objects from every day life, rural festival, circus, historical figures.
 2. Quilts, wedding mats, bags, wraps for mirror, Jewellery, etc.
 3. Done in chain stitches with white, green purple, red, brown, yellow, grey and black figures of horse, kings, birds, bees, etc.
 4. Kalighat Patachitra

GLOSSARY

- Queen Victoria – British Queen who ruled India
- Lenin – Communist leader of Russia
- Patachitra – Paintings by Kalighat artists of Bengal
- Pichuai – Back drop scroll painting of Rajasthan.
- Alpana – Floor decoration of Bengal
- Sanjhi – Folk wall painting of Uttar Pradesh
- Terracotta – Burnt clay
- Symbolic – Something used for representing something else.
- Utilitarian – Useful objects used in every day life.
- Ritualistic – Objects used for religious purposes
- Individualistic – Personal style.



5

RENAISSANCE

Renaissance is a word which means “Re-Birth”. Thus it stands to depict the revival of Art, Architecture and Literature in 14th to 17th century. **Renaissance** began with the revival of interest in ancient classical culture of **Greeks and Romans**. This period was known for new experiments, power of reasoning, laws and discoveries. Thus it was called the “**Age of Enlightenment**”. **Renaissance** had spread from **Early Renaissance** to **High Renaissance** and finally to **Mannerism and Baroque**.

Though, 14th century **Renaissance** with prominent Artists like **Duccio** and **Masaccio** had more gothic method of narration and less anatomy knowledge, yet they show sense of scientific proportion and observation in their painting. 15th Century **Renaissance** gave enough stress to balance and harmony in Art and Nature. The use of light, shadow, foreshortening and perspective had been perfected. The most famous painters of this period are **Leonardo da Vinci, Raphael** and **Michael Angelo**. **Mannerist Artists** extended the principles of **High Renaissance** and tend to represent elongated figures in illogical spaces. Here, the emphasis was given more to show human soul with anatomically corrected human body.



OBJECTIVES

After studying this lesson, the learner should be able to:

- explain the evolution of **Renaissance**;
- describe the development of this period;
- write about the Artists and their working style;
- identify the enlisted Art works.



Notes



BIRTH OF VENUS



Notes

5.1 BIRTH OF VENUS

Title	–	Birth of Venus
Artist	–	Sandro Botticelli
Medium	–	Tempera on canvas
Period	–	1485-1486
Style	–	Renaissance
Collection	–	Galleria degli Uffizi in Florence

GENERAL DESCRIPTION

Sandro Botticelli painted **Birth of Venus** in about 1486. This painting shows one of the best examples of rebirth of classical motifs inspired by 2nd century ancient Greek masterpieces. The painting depicts the classical goddess ‘**Venus**’ emerging from the water on shell. The nude goddess is a representation not of earthly but spiritual love. She arrives as a full grown woman, symbolizing beauty and truth. She is joined by one of the goddesses of seasons, who offer her cloth embroidered with flowers to cover her body. On the other side emerges wind god like angels free flowing in air. Venus stands in the centre with modest pose which recalls ancient Gothic’s sculptures. The anatomy of Venus does not display the strict classical realism, as she is shown with elongated neck and her left shoulder slopes at unusual angle. She bears slim and long limbs. The cool artificial light adds soft harmonious beauty to the painting.



INTEXT QUESTIONS 5.1

- What is shown in the picture “**Birth of Venus**” by **Botticelli**?
- What does **Venus** symbolize in this painting?
- What is the nature of the anatomy of **Venus**?
- What is the nature of light in this painting?

5.2 MONA LISA

Title	–	Mona Lisa
Artist	–	Leonardo da Vinci
Medium	–	Oil on Poplar Wood
Period	–	16 th century
Style	–	Renaissance
Collection	–	Louvre Museum, Paris



Notes

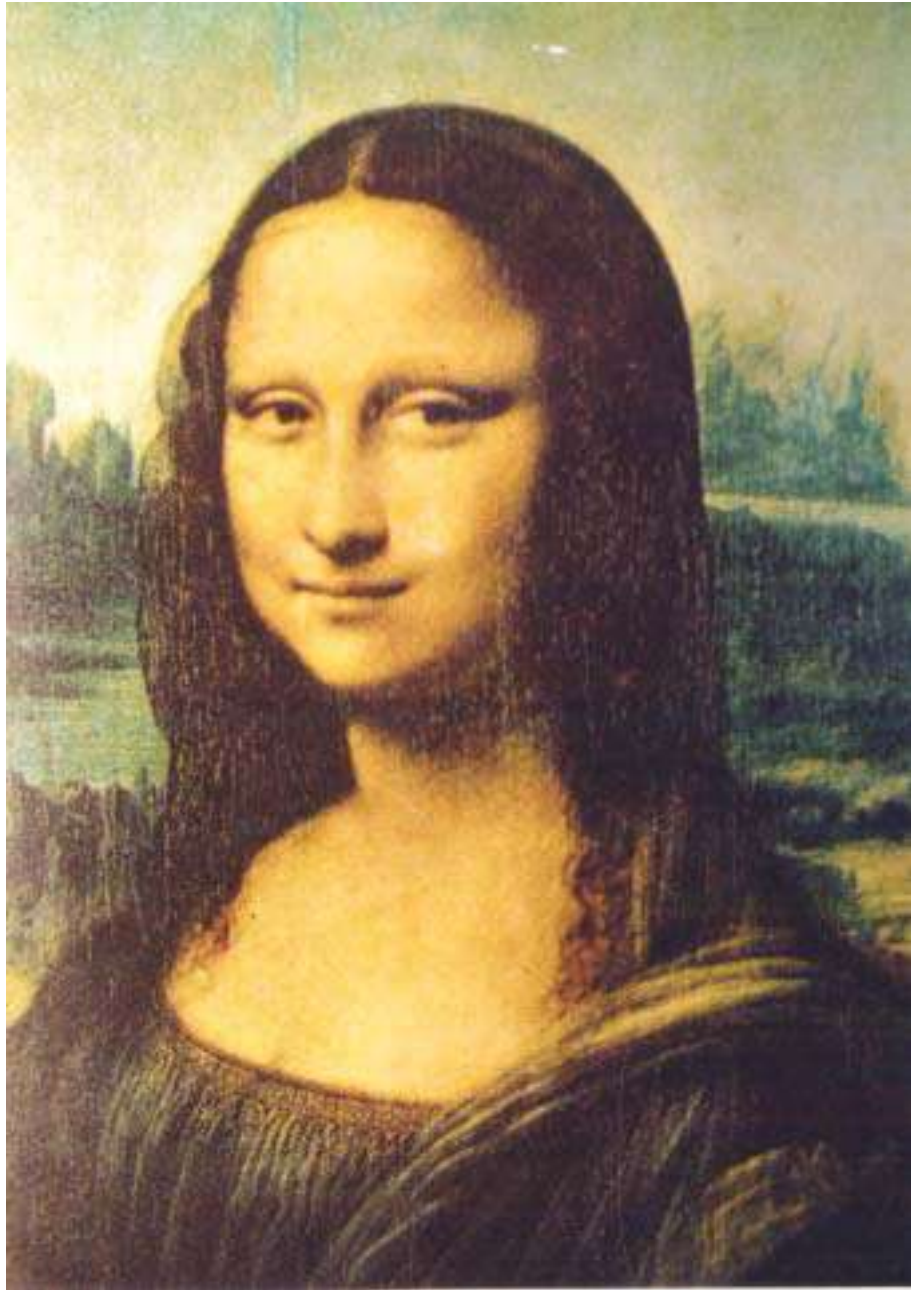

MONALISA



Notes

GENERAL DESCRIPTION

Leonardo da Vinci (1452-1519) was an Italian painter. He was regarded both as scientist and artist. Among many famous paintings, ‘**The Last supper**’, ‘**The Virgin of the Rocks**’ and ‘**Mona Lisa**’ stand for ever universal fame. **Mona Lisa** was painted in 16th century on poplar wood in oil colours. It depicts a woman sitting with a mysterious smile which seems to welcome the observer. **Leonardo** used a pyramid design, where her folded hands form the base. There is a dramatic contrast of light and dark. The brightly lit face is framed with various elements like hair, veil, and shadows. In the portrait of **Mona Lisa** there is no visible facial hair, even eyebrows and eyelashes are shown missing; still the smile on the woman’s face depicted more striking when looking at the portrait’s eye than when looking at the mouth itself. There is a vast landscape behind the portrait. It depicts icy mountain, valley and curved river. The representation of the painting **Mona Lisa** reflects **Leonardo’s** vision to connect humanity with nature.



INTEXT QUESTIONS 5.2

- Write on the different areas in which **Vinci** contributed.
- Why is **Mona Lisa** appreciated so much?
- What is the background of this painting?
- What is the medium of painting **Mona Lisa**?

5.3 PIETA

Title	–	Pieta
Artist	–	Michael Angelo
Medium	–	Marble sculpture
Period	–	1498-1499
Style	–	Renaissance
Collection	–	St. Peter’s, Rome

GENERAL DESCRIPTION

Pieta is a sculpture made by **Michael Angelo** in 1498-1499. It is created from a single slab of marble. This famous work shows ‘**Virgin Mary**’ holding the dead body of **Christ** in her hands. The mother sits while Christ rests dead on her lap. The interpretation of his works balanced the Renaissance ideals of classical beauty and



Notes



PIETA

artist's own creative expressions. The structure of this sculpture is pyramidal in shape. Here he depicts **Madonna** much younger than her son, the Christ to express her purity. This is the most highly finished work of **Michael Angelo**. The sculpture has unique drapery movements and strong anatomy details. The other famous works of art created by **Michael Angelo** are the sculpture of '**David**', '**Moses**' and the **Frescoes** on the ceiling of the Sistine chapel in Rome.



INTEXT QUESTIONS 5.3

- What is the theme of '**Pieta**'?
- How many figures are used in the sculpture "**Pieta**"? Name the characters in this sculpture.
- Write the basic structure of "**Pieta**".

5.4 THE NIGHT WATCH

Title	–	The Night Watch
Artist	–	Rembrandt
Medium	–	Oil on Canvas
Period	–	1642
Style	–	Renaissance (Baroque)
Collection	–	Rijks Museum, Amsterdam

GENERAL DESCRIPTION

Rembrandt was a Dutch painter. He was a realist. In most of his paintings, we see the mysteries in the play of light and shade. This tends to highlight the 'soul' of the painting. **Rembrandt** painted '**Night Watch**' between 1640-1642. For a long time the painting was kept coated with a dark varnish which gave the incorrect impression that the painting depicted a night scene but when the varnish was removed in 1940 it was discovered to represent broad day light.

This painting illustrates the young captain giving order to his lieutenant to march his Company civilians. The painting shows effective use of light and shadows. The captain is dressed in black with a red sash. The lieutenant and a small girl are shown wearing yellow dress which also symbolizes the colour of victory. There is also a white dead chicken hanging from the girl's belt shown to represent defeated enemy. In the background stands a drummer to energize the march. The painting shows the mastery to depict the traditional-military portraits with expression.





Notes



THE NIGHT WATCH



INTEXT QUESTIONS 5.4

- (a) Mention the characteristic features of **Rembrandt's** painting.
- (b) Write on the theme of “**The Night Watch**” by **Rembrandt**.
- (c) What does this painting illustrate?
- (d) When was the varnish removed from the surface of this painting?

Notes



WHAT YOU HAVE LEARNT

Renaissance means ‘rebirth’, thus it stands to depict revival of ancient classical culture. It spread from **Early Renaissance**, **High Renaissance** to **Baroque**. Renaissance gave more stress to anatomical corrected human body with perspective, foreshortening and pyramidal composition and play of dramatic light became the common feature of this period. The most famous artist of this period are **Masaccio**, **Botticelli**, **Leonardo da Vinci**, **Raphael**, **Michael Angelo**, **Rembrandt** and **Rubens**.



TERMINAL EXERCISES

1. What do you mean by the word ‘**Renaissance**’? Explain the main features of this period?
2. How ‘**Venus**’ is being represented in the painting ‘**Birth of Venus**’?
3. Describe the painting ‘**Mona Lisa**’?
4. Write a short note on the sculpture ‘**Pieta**’?
5. Describe the painting ‘**Night Watch**’?



ANSWERS TO INTEXT QUESTIONS

1. (a) Venus emerging from the water on shell.
- (b) Venus symbolizes beauty and truth.
- (c) It does not follow classical realism, rather it is elongated.
- (d) Cool, artificial light.



Notes

2. (a) Painter, scientist.
(b) A mysterious smile which seems to welcome the observer.
(c) Landscape with mountain, valley and river.
(d) Oil on poplar wood.
3. (a) **Virgin Mary** holding the dead body of **Jesus**.
(b) Two, **Mary** and **Jesus**.
(c) Pyramidal
4. (a) Mysteries in the play of light and shade.
(b) Not a night scene but a day scene.
(c) The young captain giving order to his lieutenant to march his company.
(d) 1940

GLOSSARY

1. **Anatomy** – Science of body structure.
2. **Cloak** – Over garment hanging loosely from shoulders
3. **Dramatic** – Play of exciting or emotional event
4. **Elongated** – Stretched out
5. **Frescoes** – Wall painting done in watercolour/tempera
6. **Foreshortening** – Showing a object shortening at distance due to perspective
7. **Humanity** – Human race
8. **Interpretation** – Explanation
9. **Mannerism** – Style of some 16th Italian painters who exaggerated the formulae of design of High Renaissance painters.
10. **Narration** – Depicting the concerned event
11. **Spiritual** – Religious
12. **Pyramidal** – Structure with square base and sloping sides meeting at centre.



6

IMPRESSIONISM

'Impressionism' was an artistic movement that drew inspiration from the simplicity of everyday life. The name **'Impressionism'** was given by an art critic at the first exhibition of this art group in 1874. The artists of impressionism followed a style or movement in art concerned with the effect of light on objects. They came out of the studio to paint in open air, working quickly to create an impression of what they felt in visible universe. These artists attempted to capture freely and spontaneously the natural, ever changing effects of light and colour. Impressionist came to represent a major break between classical and modern painting. For impressionism, like most movements, was a rebellion against the conventional and academic standards, which in every age seem to have the support of the masses. Here, the artists were more attracted to subjects, such as rivers, pools, harbours, cityscape and human forms. Some of the pioneering artists of this movement were **Claude Monet, Eduardo Manet, Auguste Renoir and Edgar Degas.**

Post Impressionist was both an extension of impressionism and a rejection of their limitations. Though Post Impressionist continued the use of distinctive brush strokes applying vivid colours. The selection of subjects were from real life, but they gave more importance to geometrical forms or distorted forms to express feelings of their inner version. **George Seurat** and his followers concerned themselves with pointillism; the systematic use of tiny dots of colour. **Paul Cezanne** introduced a sense of volume and structure to painting, while **Gauguin and Vincent Van Gogh** used colours and vibrant swirling brush strokes to convey their feelings and their state of mind.

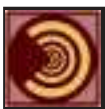

OBJECTIVES

After studying this lesson, the learner should be able to:

- identify the main features of these art movements;

MODULE - 2

*Introduction of
Western Art*



Notes

Impressionism



WATER LILIES

- differentiate the different stylistic approach of paintings done by impressionists;
- mention the style of enlisted artists;
- describe the formation of “**impressionism**”.
- state the pioneers of these Art Movements.

6.1 WATER LILIES

Title	–	" Water Lilies "
Artist	–	Claude Monet
Medium	–	Oil colours
Period	–	1899
Style	–	Impressionism
Collection	–	National Gallery, London

GENERAL DESCRIPTION

Among the entire Impressionists, **Claude Monet** was the most dedicated and spontaneous artist to capture ever changing moods of nature. He was born in Paris on 14th November 1840. Most of his life, he travelled tirelessly seeking new settings and effects of nature to paint. He is widely regarded for his enchanting flower-landscape, river with boats, seascape and rock coast. He endlessly painted the wonderful water-garden which gave him his final great public recognition. In the series of “**Water Lilies**” in 1899-1900, the ‘Japanese Bridge’ across the pond acted as the central features of the paintings. In almost all these paintings the sky was barely absent but he freely painted its brilliant reflections in many vibrant colours to add extraordinary depth. The fresh blossomed **Lilies** of various sizes add to the beauty of the painting.



INTEXT QUESTIONS 6.1

1. Who did paint the "**Water Lilies**".
2. What is the style of **Monet's** technique?
3. What did **Monet** want to capture in his painting?
4. What is the role of sky in his paintings?



MODULE - 2

*Introduction of
Western Art*



Notes

Impressionism



MOULIN DE LA GALETTE



Notes

6.2 MOULIN DE LA GALETTE

Title	-	Moulin de la Galette
Artist	-	Auguste Renoir
Medium	-	Oil on Canvas
Period	-	1876
Style	-	Impressionism
Collection	-	Musee De L'impressionnisme, Paris

GENERAL DESCRIPTION

Auguste Renoir (1841-1919) was a French Artist. He painted '**Moulin de la Galette**' in 1876. The painting shows young people enjoying life, picnics, dance and party. **Renoir** was a creator of soft, sentimental and charming paintings. While painting he used his sharp observation to register the movement, atmosphere and images of Parsian society. He used shades of purple, white and blue tones to unite the modelling of figures dressed in fashionable clothes. He added delight and freshness in colour which sparkles life in his painting. His works show tenderness and harmony in perfectly balanced and pleasant compositions. **Renoir** prefers to paint group composition, portraits and female model studies. He was expert to communicate the impression of joy of life through his paintings.



INTEXT QUESTIONS 6.2

1. What is the name of the painter of **Moulin de la Galette**?
2. Mention the style of the painting **Moulin de la Galette**.
3. What was his preference in choosing a theme?
4. What do his works show besides pleasant composition?

6.3 DANCE CLASS

Title	-	Dance Class
Artist	-	Edgar Degas
Medium	-	Oil on Canvas
Period	-	1873-1876
Style	-	Impressionism
Collection	-	Museum of Art, Toledo, Ohio (USA)

MODULE - 2

*Introduction of
Western Art*



Notes

Impressionism



DANCE CLASS



Notes

GENERAL DESCRIPTION

The painting '**Dance Class**' was created by a French painter **Edgar Degas** born in Paris, (Naples) in 1834. Unlike other impressionist **Edgar Degas** refused to paint from nature. He was interested mainly in human presence. Among his most notable achievements are his paintings of ballet dancers in frills skirts practicing, getting ready or just revolving around the stage. His off centred composition gave impression of spontaneity to capture gesture or a pose full of life. In most of his paintings he preferred to play with artificial light of the theatre, than to sunlight. His most favourite medium was pastel. Sometimes he used different mediums in the same picture or else he would superimpose coats of pastel in order to obtain transparencies between layers. Other than painting, **Degas** also took up sculpture to express rhythmic movements of dancers in real space.



INTEXT QUESTIONS 6.3

1. Why was **Degas** different from other impressionist painters?
2. Which medium of colours did he prefer to use?
3. Why did **Degas** make sculpture?
4. When did he paint "**Dance Class**"?

6.4 STILL LIFE WITH ONIONS

Title	-	Still Life with Onions
Artist	-	Paul Cezanne
Medium	-	Oil on Canvas
Period	-	1895-1900
Style	-	Post Impressionism.
Collection	-	Musee d'Orsay, Paris

GENERAL DESCRIPTION

Paul Cezanne (1839-1906) was a post-impressionist who explored new means of expression. His paintings show simplification of natural forms. According to him everything in nature could be reduced to solid geometrical such as cone, cylinder, and cube. He tends to turn recognised or real forms into structural impression. Thus he was said to start '**abstract painting**', which later gave birth to **Cubism**. He is known as '**Father of Cubism**'. Whether it was his still life, landscape, portrait, or familiar humble folk, all his paintings convey intense study of the selected



Notes



STILL LIFE WITH ONIONS

subject. In his painting ‘**Still Life with Onions**’, he rendered forms by interpreting the light and shade of an object in varying tones of same colours. He used plane colour strokes to depict colour relations. His composition shows perfect vertical and horizontal breaks with interesting arrangement of three-dimensional forms in space. With the use of red and yellow, the vibration of light is reproduced, while sufficient quantity of blue and white drapery adds the feeling of air and space. **Cezanne** would be always regarded as the father of modern painting as his style forms the bridge between the late 19th century **impressionism** and the early 20th century **modernism** or **cubism**.



INTEXT QUESTIONS 6.4

1. What is **Cezanne**’s contribution to the development of ‘**Cubism**’?
2. Write two important features of his painting “**Still Life with Onions**”.
3. What is his style of painting?
4. Why is he regarded as "**Father of Cubism**"?

6.5 STARRY NIGHT

Title	-	Starry Night
Artist	-	Vincent Van Gogh
Medium	-	Oil colours
Period	-	1889
Style	-	Post Impressionism
Collection	-	National Gallery, London

GENERAL DESCRIPTION

Vincent Van Gogh (1853 - 1890) was a Dutch painter. Though his life was full of miseries, poverty and discouragement, he was a dedicated painter. In all of **Van Gogh**’s paintings, colour carries greater importance than just the expression of the forms. He tends to depict natural scenes in terms of colours, not light and shade. In his painting ‘**Starry Night**’ there is a night sky filled with stars. His painting shows well balanced compositions with harmony of colours. The painting is composed with various elements like swirling cloud, glowing stars and a bright moon. In the background below the hills lies a small town with a church and small buildings. To the left of the painting there is a massive dark structure depicting top of an isolated cypress tree. The stars in the night sky are surrounded with their own orbit of light.





Notes



STARRY NIGHT

This representation of the sky keeps the viewer's eyes moving about the painting, following the curves. His **Starry Night** seems to be a 'whirlpool galaxy' with bold pure slabs of blue and white oil colours. This study of night sky led to convey his own inner conflicts and sleepless nights. **Van Gogh** had an original vision to depict the simplicity and acuteness of expression. His other famous paintings that made him one of the most outstanding painter are **Sunflower, Potato Eater, Wheat Field** and **Cypresses, his own Self Portrait** and his **Own Bedroom**.



INTEXT QUESTIONS 6.5

1. What does carry most importance in **Van Gogh's** Painting?
2. To which country he belonged?
3. Mention some of his famous paintings.
4. What does "**Starry Night**" convey?



WHAT YOU HAVE LEARNT

Impressionism symbolises an Artistic movement which tends to produce an effect to mark impression of a feeling or imagination. The Artists of Impressionism came out of the studio to paint in the open air, working quickly to create an Impression of what they saw. Some of the famous artists of this movement were **Monet, Manet, Renoir** and **Degas**. While Post-Impressionism was an extension of and rejection of limitation of Impressionism, they gave more importance to the inner feelings, sense of volume and use of vibrant colours. The pioneer of this movement was **Seurat, Gauguin, Cezanne** and **Van Gogh**.



TERMINAL EXERCISES

1. What does Artistic movement **Impressionism** symbolises?
2. Write a short note on the painting '**Moulin de la Galette**'.
3. Explain **Van Gogh's** representation in the painting '**Starry Night**'.
4. Describe the painting '**Water Lilies**'.
5. Describe the painting "**Starry Night**" in few words.





Notes



ANSWERS TO INTEXT QUESTIONS

6.1

1. Monet
2. Impressionism
3. Ever changing moods of nature
4. Barely absent.

6.2

1. Renoir
2. Impressionism
3. Group composition, portraits and female models.
4. Tenderness, harmony and balance.

6.3

1. His interest was in Human figures, not Nature as of other impressionists.
2. Pastel
3. To express rhythmic movement.
4. 1873-1876

6.4

1. Simplification of natural form into solid geometricals as cone, cylinder and cube.
2. Plane colour strokes, perfect horizontal and vertical composition, arrangement of three dimensional forms in space.
3. Post Impressionism.
4. His style forms the bridge between the late 19th century **impressionism** and the early 20th century **cubism**.

6.5

1. Colour
2. Holland

3. **Sunflower Potato Eater, Wheat Field and Cypresses.**
4. Conveys his own inner conflicts and sleepless night.

GLOSSARY

1. **Acuteness** - Reaching the extreme.
2. **Distinctive** - Different Characteristics
3. **Isolated** - Lonely, Cut off from the society
4. **Literally** - Exactly
5. **Pioneer** - A person who is the first to study and develop a particular area of knowledge, culture, etc.
6. **Spontaneity** - Occurring naturally.
7. **Swirling** - Pattern of twist or curl
8. **Transparencies** - A picture made visible by audio
9. **Whirlpool** - Swinging in circular motion in sea, etc.



Notes

MODULE - 2

*Introduction of
Western Art*



Notes

7

CUBISM, SURREALISM AND ABSTRACT ART

Cubism is a style of painting and sculpture, that began in Paris in about 1907. It was the most important trend at the beginning of 20th century. **Cezanne** was the pioneer of **cubism**. He said, "**Everything in nature must be treated as a cylinder or sphere**". The important artists included **Picasso, Braque and Leger**. They particularly chose subjects like still life, landscapes and portraits and the motifs in their works were broken up into small parts. The aim was to give importance on construction but not the emotions. The purpose was presenting the form, not richness of colour in terms of geometrical shapes. Forms became increasingly abstract and generalized. By 1920, this art movement came to an end.

Surrealism was another movement which started in 1924 and continued till 1955. The Surrealist artists tried to use the images of the unconscious in their works. The Surrealists considered themselves representatives of new outlook, mainly influenced by psycho-analysis. It originated as a revolutionary movement resulting from the **Dadaist's** revolt. **Giorgio de Chirico and Salvador Dali** were the most famous surrealist painters.

Abstract art is a general term for non-representational art, an art form that rejects the depiction of the contemporary world in a realistic way. It started in the year 1910. The pioneers of abstract paintings are **Kandinsky, Delarunay and Mondrian**. They tried to give a pictured form to depict abstract ideas which is not possible to represent in a realistic method.



OBJECTIVES

After studying this lesson, learner will be able to:

- 1 describe evolution of **Abstract Art, Cubism and Surrealism**.

MODULE - 2

*Introduction of
Western Art*

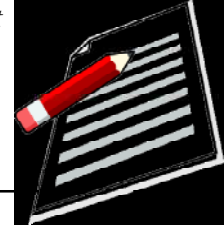

Notes

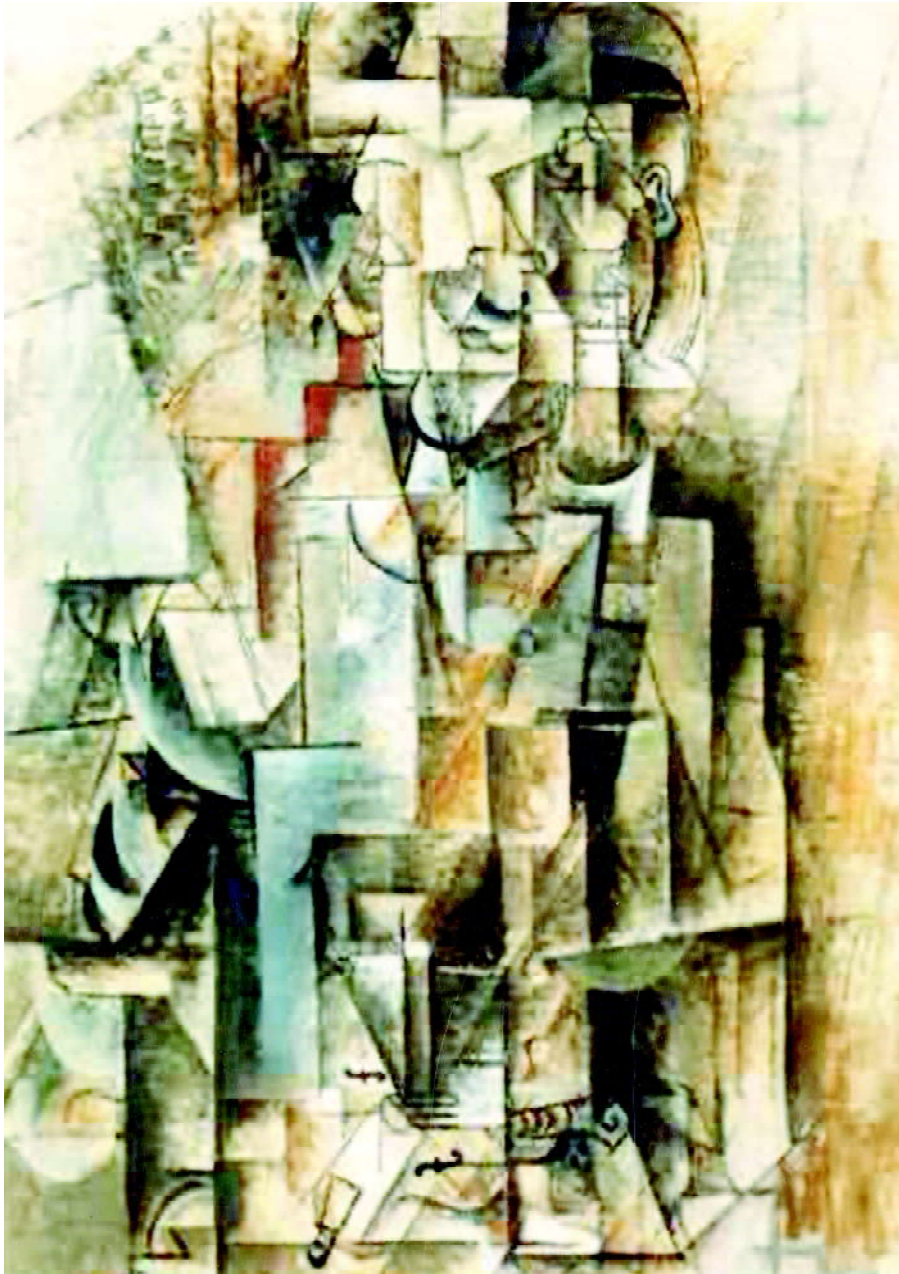

MAN WITH VIOLIN

MODULE - 2

*Introduction of
Western Art*

Notes

Cubism, Surrealism and Abstract Art

- | state the names of artists, methods and materials, sizes, themes and places of enlisted paintings.
- | tell the title of enlisted paintings.
- | differentiate between abstract art form and other arts.
- | identify **Abstract Art**, **Cubism** and **Surrealism** from other art movements.

7.1 MAN WITH VIOLIN

Title	: Man with Violin
Medium	: Oil on canvas
Date	: 1912
Size	: 100 x 73 cm
Artist	: Pablo Picasso
Collection	: Philadelphia Museum of Art

GENERAL DESCRIPTION

Pablo Picasso was born in 1881 in **Malaga, Spain**. He was a painter, sculptor, and ceramist. Throughout his long career, **Picasso** followed the principles of abstract composition. He was highly influenced by symbolism. He developed his own style in Paris during his **Blue Period, 1900- 1902**, named from the blue green tone of his canvases. **Picasso** developed his **Rose Period in 1905-1907**. In this period he used mainly pink colour in his paintings. After this period, his works were influenced by the African artifacts. From 1915, **Picasso** developed his **Cubist phase** which made him famous world over. **Cubism** is basically the breaking of three-dimensional forms into flat areas of pattern and colour, overlapping and linking so that shapes and parts of the human body or objects are seen from the front and back at the same time.

“**Man with Violin**” was painted in 1912. It is a fine example of **Analytical Cubism**. Objects were divided into parts depicting different viewpoints at the same time. Like any other painting of this period, forms are recognizable, but broken down into cube-like forms. **Picasso** tried to use space in a new way. The human form holding the violin is broken into various geometrical shapes and then arranged together. The colours used are typical of this period, using the shades of browns and green. Most of his paintings during this period were made with similar technique and colours. In this painting there is a continuous unity of form and colour. For him, reality had a different definition. He defined reality in a sense more real than that of nature. His brilliant and unusual way of handling paints and other materials made him most admired artist of the 20th Century. His one of the best works is '**Guernica**' based on Spanish civil war.

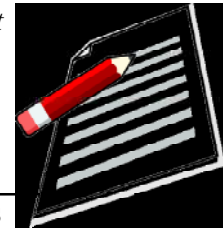

Notes

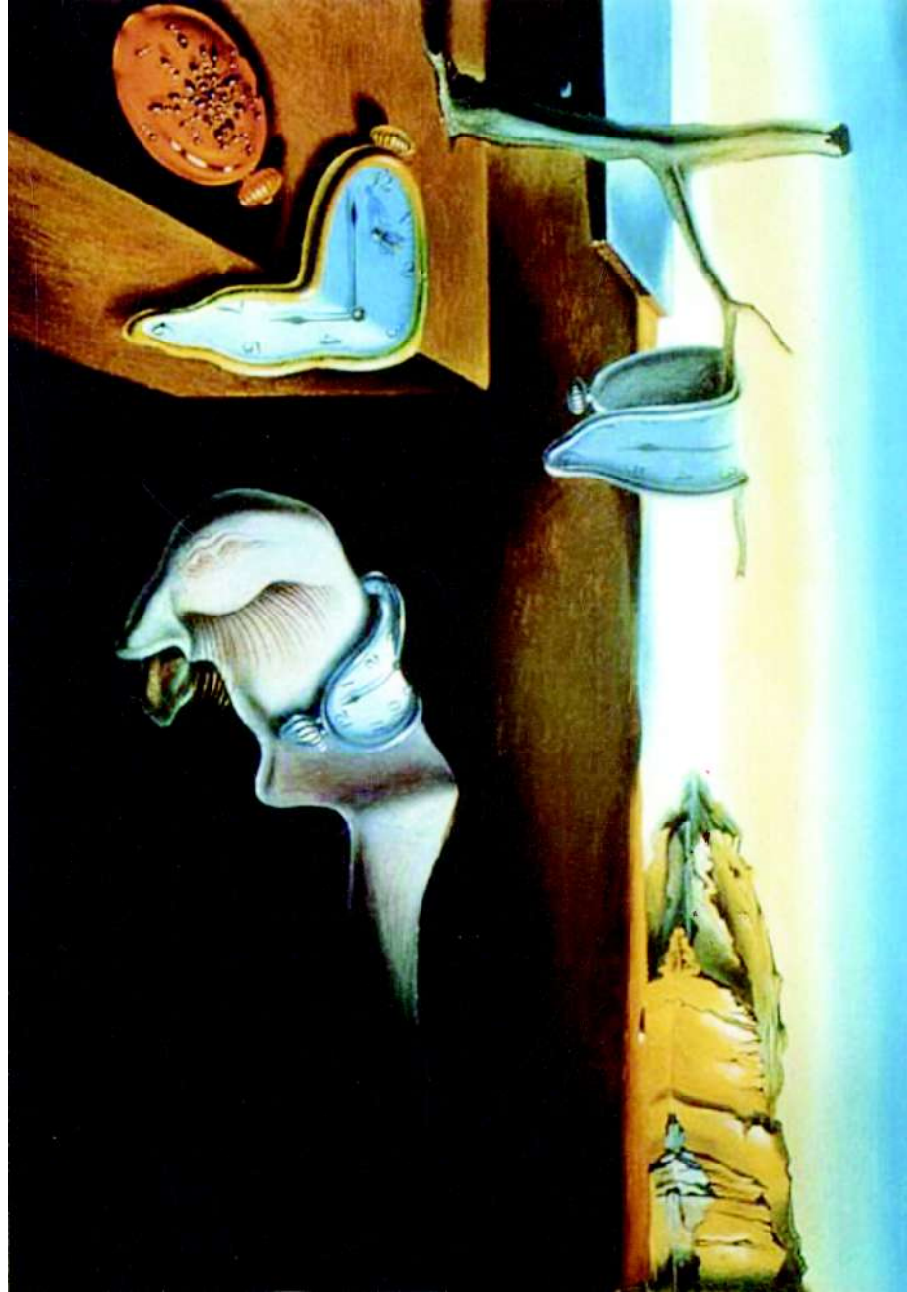

PERSISTENCE OF MEMORY

MODULE - 2

Introduction of
Western Art

Notes

Cubism, Surrealism and Abstract Art



INTEXT QUESTIONS 7.1

1. Mention two of **Picasso's** famous periods.
2. What style made him famous?
3. When did he paint "**Man with Violin**"?
4. What are the years of the **Rose Period**?
5. On what subject **Picasso** painted '**Guernica**'?

7.2 PERSISTENCE OF MEMORY

Title	: Persistence of Memory
Medium	: Oil on canvas
Date	: 1931
Size	: 9½" x 13"
Artist	: Salvador Dali
Collection	: Museum of Modern Art, New York

GENERAL DESCRIPTION

Salvador Dali is the most famous **Surrealist** painter. He was a Spanish painter, film maker and writer. He adopted highly realistic technique. He continued with his practice of drawing which he had mastered in his youth while studying. After a brief period of experimenting with form, he used his drawings to depict the world of absurd, unusual and strange elements.

“**Persistence of Memory**” painted in 1931 is a fine example of **Surrealist Movement**. The bare landscape and calmness depicted in this painting could be regarded as life after all wars, after all humans have died. The only objects in the painting that give life and which can be associated with people are the “melting clocks”. In this painting the melting clocks look very realistic and create the sense of disturbed mind which we all see in most of his paintings. **Dali's** own style was academic and precise but his subject matter was from his dreams or nightmares. The unconventional grouping of objects in **Dali's** pictures has a symbolic meaning. These soft watches create new and unpleasant images. Ants crawl over another, as they would over rotting food; their forms create a jewel like ornament covering the watch's surface. All his paintings create a different kind of pictorial language. None of **Dali's** paintings represent reality. They look as if nothing more than a few objects here and there which are out of place.

Though he was a great artist with talent and imagination, he had a way of doing

MODULE - 2

*Introduction of
Western Art*

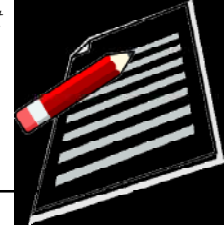

Notes



BLACK LINES

MODULE - 2

*Introduction of
Western Art*

Notes

Cubism, Surrealism and Abstract Art

unusual things to draw attention to himself which many a times have annoyed those who loved his art as well as his critics. His eccentric theatrical manner was as prominent as his artwork and attracted lot of public attention. He died in 1989 and left behind him fantastic works such as “**Vilabertin**”, “**Large Harlequin**”, “**Small Bottle of Rum**” and “**Honey is Sweeter than Blood**”.



INTEXT QUESTIONS 7.2

1. What is the style of **Salvador Dali**?
2. What technique did he adopt?
3. Give an example of **Dali's** Surrealist painting.
4. What do you see in the painting "**Persistence of Memory**"?

7.3 BLACK LINES

Title	:	Black Lines
Medium	:	Oil on canvas
Date	:	December 1913
Size	:	4' 3" x 4' 3 $\frac{1}{4}$ "
Artist	:	Wassily Kandinsky
Collection	:	Solomon R. Guggenheim Museum, New York

GENERAL DESCRIPTION

Wassily Kandinsky was born in 1866 in Russia. He was a famous painter and art theoretician of his time. **Kandinsky** is one of the founder figures of **abstract painting**. He laid the foundations for non-representational art in his three important series—**Impressions**, **Improvisations** and **Compositions**. His works were combination of abstraction and geometric. He wanted painting to be abstract like music is. “**Accompanied Contrast**”, “**Yellow Accompaniment**”, “**Angular Structure**” are some of his great works. His works had an enormous influence on the next generation of artists.

“**Black lines**” was done by **Kandinsky** in the year 1913. As the name suggests, the lines look as if they were put on with Indian ink but actually black paint was used. In this composition, a group of lines in a particular corner added different meanings according to the arrangement. Like other paintings of this period, his work showed simplicity and pure diagrams as if skeletons have no flesh on it. The coloured spots look as if applied by fingers of a giant hand and not brushes. They go well with the lines and its effect.

Cubism, Surrealism and Abstract Art

For **Kandinsky**, line, shape, and colour all had their own meaning and function freely within the area. In most of his paintings, lines are sketchy and look as if they have lives of their own. He spent last part of his life in Paris where he died in 1944.



INTEXT QUESTIONS 7.3

1. What is the main contribution of **Kandinsky** to the modern art?
2. Name three important series of **Kandinsky**?
3. When did he paint "**Black lines**"?
4. What is the medium of this painting?



WHAT YOU HAVE LEARNT

An important phase in Western Art began with the foundation of **Abstract Art**. Other art movements followed and there was a continuous change in understanding art. We find the influence of **Abstract Art** in works which can not be related to realism. Any work which is non representational is considered **Abstract Art**. Though **Abstract Art**, **Cubism** and **Surrealism** originated in the West, it left a deep impression on Indian artists and greatly influencing their many works.

Wassily Kandinsky, **Salvador Dali** and **Pablo Picasso** have left remarkable works for the future generation of artists as an inspiration. Though they represented important phases in these new movements, they remained very individualistic. His works showed the distinction from realistic work of the earlier periods. **Cubism** originated along the lines of **Abstract Art** and **Picasso** became famous for his **Cubist** paintings and sculptures. His works showed different periods and each period was very distinct from the other. **Dali**, who had a very interesting and unusual life, was the most famous amongst the **Surrealist Painters**. The beginning of the phase of **Abstract Art** starts with the works of **Wassily Kandinsky**.



TERMINAL EXERCISES

1. Write short note on **Cubism**.
2. Briefly describe **Salvador Dali**'s contribution to **Surrealism**.
3. Write a paragraph on **Kandinsky**'s painting "**Black Lines**".
4. Write a brief note on **Abstract Art**.
5. Write in brief about **Pablo Picasso**.

MODULE - 2

Introduction of
Western Art

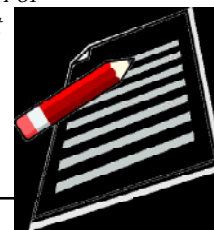

Notes

MODULE - 2

*Introduction of
Western Art*



Notes

Cubism, Surrealism and Abstract Art



ANSWERS TO INTEXT QUESTIONS

7.1

1. Blue, Cubism
2. Cubism
3. 1912
4. 1905-1907
5. Spanish civil war.

7.2

1. Surrealism
2. Highly realistic technique
3. Persistence of Memory
4. Landscape, melting clocks, ants

7.3

1. Abstract painting
2. Impression, Improvisations and compositions
3. 1913
4. Oil on canvas

GLOSSARY

Impact	–	influence
Motifs	–	pattern
Unconscious	–	without awareness
Symbolism	–	the practice of symbols in art
Artifacts	–	work of art
Mystical	–	magical
Eccentric	–	a person who has unusual personality
Pictorial	–	illustrative
Dadaism	–	An art style of 20 th century in which normal rules of art are challenged.
Psycho analysis	–	A process to analyse mind of a person.



8

PIONEERS OF CONTEMPORARY INDIAN ART

At the beginning of 19th century under the influence of the British Raj, Indian art displayed a general decline. The craft and techniques of **fresco** and **miniature paintings** which were unique in the history of art, were nearly lost. Miniatures were ousted by European oil painting. Towards the turn of the century, traditional Indian painting faded out and it was the time for Indian artists to look at their heritage with positive approach and advance from the earlier European Colonial Art.

Raja Ravi Varma of Kerala was famous for his paintings of mythological subjects and portraiture. His works showed western influence in his oil paintings. On the other hand, **Abanindranath Tagore** tried to recreate a new style in painting. **Nandalal Bose**, **Benode Behari**, and few others followed this newly awakened sense of nationalism. Thus emerged the Bengal School in the first half of 20th century. For subjects, they found their inspiration from Indian classics and mythology. They rejected the **western realism** and preferred to use **idealism of Indian Art**. **Jamini Roy** gave a modern form to **folk art** and **Rabindranath Tagore** introduced **expression** in his painting. These artists experimented with traditional water colour techniques using Indian and Chinese styles and also sought inspiration from **miniatures, frescoes and folk art**.

Later, artists like **Amrita Shergil** drew on both Western and Indian traditions. Her contribution in the field of art retains her unique position as the first lady of the modern Indian art. All these artists produced remarkable works in the history of contemporary Indian Art.

MODULE - 3

*Introduction Contemporary
Indian Art*



Notes

Pioneers of Contemporary Indian Art



HAMSADAMAYANTI



OBJECTIVES

After studying this lesson, learner will be able to:

- describe the evolution of modern art movements in India;
- explain characteristic features of the enlisted paintings;
- state the name of methods and materials, sizes, themes and places of enlisted paintings;
- tell the name of artists of enlisted paintings;
- identify the works of enlisted artists.

8.1 HAMSA DAMAYANTI

Title	:	Hamsa Damayanti
Medium	:	Oil on canvas
Date	:	1899
Artist	:	Raja Ravi Varma

GENERAL DESCRIPTION

Raja Ravi Varma is one of the most celebrated painters of India. His life began in a small village of Kilimanoor, Kerala. **Ravi Varma's** vision as an artist was revolutionary in his contribution to Indian art. A popular and significant artist of his time he was a prominent representative of **Europeanised School of Indian artists**. He gained reputation for his water and oil colour techniques. Vast panorama of India's mythology is portrayed in series of his works that mostly project the heroines as the central figures. His paintings of Indian divinities still survive in many homes and shrines. His works are still visible in prints, calendars, posters, and other popular arts and oleographs. **Ravi Varma** is particularly noted for his paintings depicting episodes from the story of **Dushyanta –Shakuntala, Nala–Damayanti**, and from the epic **Mahabharata**.

“**Hamsa Damayanti**” is one of the most famous works of **Raja Ravi Varma**. It was painted in 1899 in oil and it created a sensation when first displayed at the **Madras Fine Arts Exhibition**. The Western technique which **Ravi Verma** mastered is clearly visible in this painting. The power and forceful expression of European painting fascinated him, which came across to him as strikingly contrasting to stylized Indian artwork.



Notes

MODULE - 3

*Introduction Contemporary
Indian Art*



Notes

Pioneers of Contemporary Indian Art

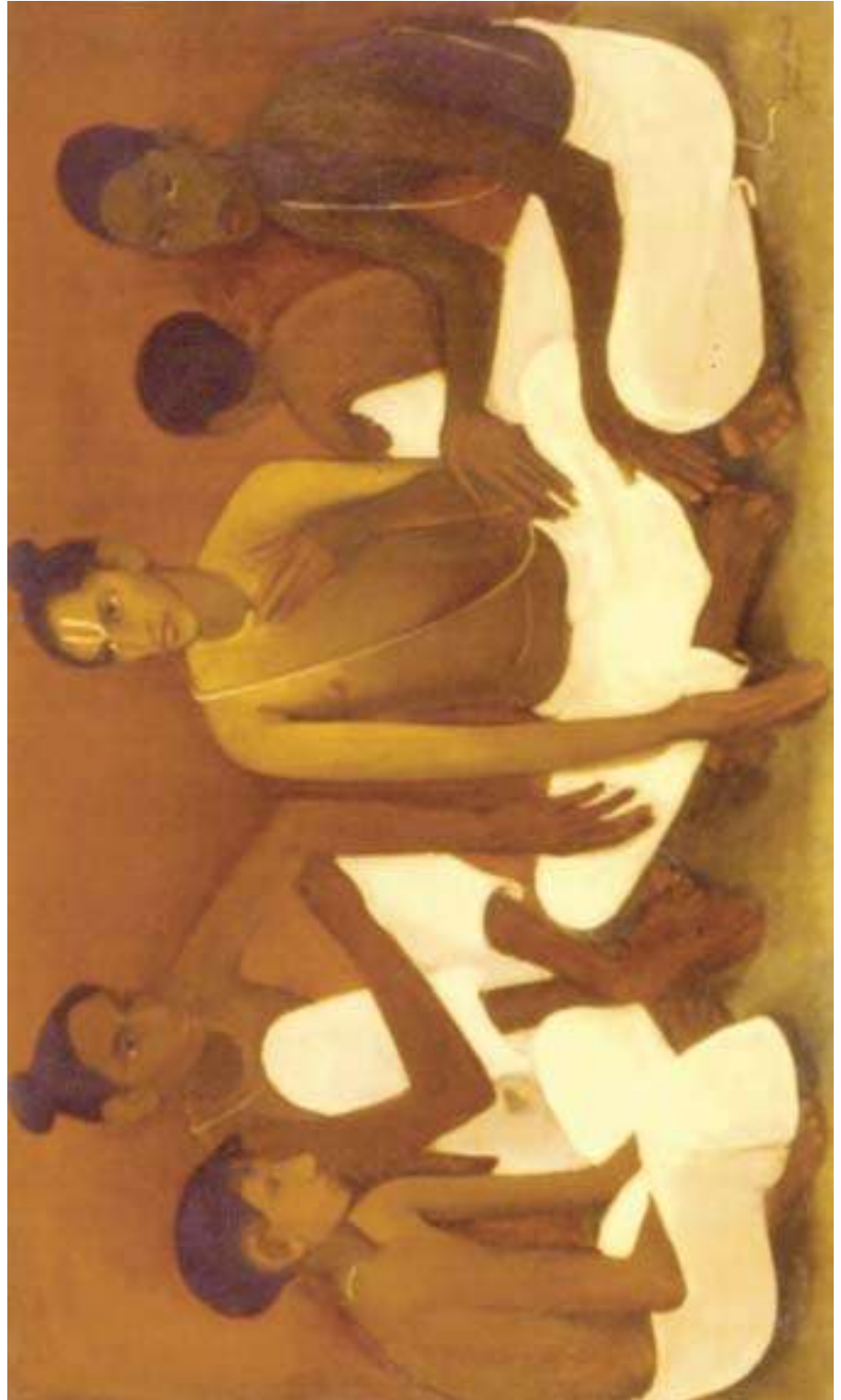

BRAHMACHARIES

The painting depicts **Damayanti**, the most beautiful of **Ravi Varma's** women, who was portrayed as very shapely and graceful. She is wearing a beautiful red **Sari**, lovingly listening to messages from her lover, **Nala**, narrated by the **swan (Hamsa)**. **Hamsa** talks about **Nala** and expresses **Nala's** love for her. The painting shows the silent love of her heart expressing itself in the sparkle of her eyes and the glow of her cheeks, tender, dignified and lovely that makes her so fascinating.

The standing figure of **Damayanti** and her posture itself is very suggestive of the theme **Ravi Varma** selected. He used oil colours in this work also because of the western influence in his paintings. He has shown his excellence in the colour combination and technique.

He provided a vital link between the traditional Indian art and the contemporary between the Thanjavoor School and Western Academic realism. **Ravi Varma** is considered not only one of India's greatest artists, but also a great patriot. **Raja Ravi Varma** breathed his last on 2nd October 1906.



INTEXT QUESTIONS 8.1

1. What is the medium of **Hamsa Damayanti**?
2. What does the painting depict?
3. What was the vital link **Ravi Varma** provided?
4. What printing process he used to reproduce his paintings?

8.2 BRAHMACHARIES

Title : **Brahmacharies**
Medium : Oil on canvas
Date : 1938
Artist : Amrita Shergil
Collection : National Gallery of Modern Art, New Delhi

GENERAL DESCRIPTION

Amrita Shergil's appearance is a great event in the history of contemporary 20th century art in India. Born in 1913, her parents were **Sardar Umrao Singh Shergil** and **Lady Antoinette**, a Hungarian national. **Amrita** spent her early years in Europe and had the best of art education in Paris. She was highly influenced by the post-Impressionists including **Modigliani** and **Gauguin**.



Notes



Notes

She came to India in 1921, drew inspiration from the exquisite little miniatures of Kangra and frescoes of Ajanta. The figures she drew with expressions on their faces were her own invention. **Amrita's** paintings were not mere reproductions of what she saw around her but visions born out of the coordination of colour, design and emotion. Visit to South India inspired her to produce the most remarkable works such as "**The Bride's Toilette**", "**The Brahmacharis**" and "**South Indian Villagers going to Market**".

The **Brahmachares** which was painted in 1938 is a fine example of her understanding of the Hindu faith which is still prevalent in the traditionalist South India. The painting shows five male figures. She saw the brahmachari students in an **ashram**. She succeeded in expressing the simplicity of these young Brahmin students as symbols of devotion in the Hindu faith. The painting is composed on a horizontal plane with vertical placement of the figures. Stress was laid on the variety of colour of the bodies. A deep red background, white *dhotis* and neutral foreground of greenish gray do not disturb the calmness of the whole composition. The *dhotis* have variations of whites, though different but so subtle that it gives an impression of uniformity. The off white of the central figure with black and brown bodies around against the deep red background are used with skill.

She is remembered for her paintings done just over a period of seven years. But the passion with which she handled the brush and the genius with which she combined her training in the West and her view of the East, made her most popular. The sincerity of her subject and the uses of colours bring to **Amrita's** paintings a quality of timelessness. Most of her paintings reflect her love for the country and more importantly her response to the life of its people. She was the youngest among the pioneers of contemporary movement and the most short lived.



INTEXT QUESTIONS 8.2

1. Which European styles influenced **Amrita** most?
2. How many figures are there on the painting "**Brahmacharies**".
3. State the main features of this painting composition.
4. In which year was it painted?



Notes



THE ATRIUM



Notes

8.3 THE ATRIUM

Title	: The Atrium
Medium	: Water colour on paper
Date	: 1920
Size	: 12.5" X 9.5"
Artist	: Gaganendranath Tagore
Collection	: Rabindra Bharati Society, Jorasanko, Kolkata

GENERAL DESCRIPTION

Gaganendranath Tagore was born in 1867 in the Tagore family in Kolkata. He was a leading figure in contemporary Indian painters. His important works from 1910-1921 were the sketches of the **Himalayas**, the life of **Chaitanya** through art in a sequence and the wonderful drawings depicting the Indian life. On one hand he supported his brother **Abanindranath** and on the other hand he showed his inclination towards **Cubist School in Europe**. Later in his career he developed a distinct style of his own and his own brand of **cubism**. The core of **cubism** was to expose in abstract geometric structures. He developed his technique after a long period of experimentation.. He overlapped the flattened geometrical shadow shapes of colour to create a mystery world. He was definitely a master of beautiful composition. He painted images with a dramatic play of light and shade using geometrical forms and simplified figures. He never blindly imitated the western art style. He was also a great critic of his time and his social cartoons were very popular. His cartoons reflected his treatment of the scenes of Kolkata and the funny side of the life of its citizens. He is best known for his political cartoons and social satires on Westernised Bengalis.

One of his paintings "**The Atrium**" is a remarkable work and a fine example of Cubist influence on his work. **Cubism** is the style in art in which objects are represented by putting together geometrical forms and he incorporated this in his works. He created this work with his cubistically broken forms like cubist. This painting particularly shows a fine blend of light and created a dramatic effect with colours. Though in most of his earlier works he used multitude of colours but in this one he has used various shades and tints. The whole composition looks like a combination of various geometrical shapes put together. This work could easily be understood though there is abstraction in the shapes. There was not any artist at that time to experiment with this western concept.

He is still regarded as an artist who made several experiments. He passed away in 1938. But his memory lives on in his paintings and sketches.



INTEXT QUESTIONS 8.3

1. What were the themes **Gaganendranath** chose to paint between 1910 and 1921?
2. Which European style influenced his painting "**Atrium**"?
3. Who do his cartoons reflect?
4. What is the medium of the painting "**Atrium**"?



WHAT YOU HAVE LEARNT

Modern Indian Art is very much related to the history of the country and social conditions in which the artists developed their styles. We see the growth of different schools after the decline of British Raj. The British Period produced significant works under the **Company School**. The Indian artists followed the European techniques in their paintings.

Artist like **Raja Ravi Varma** served as a bridge to revive Indian subjects but followed western style. Later the **Bengal School** established in Santiniketan served as a centre of artistic development. Artists of various backgrounds came together to give a new dimension to Indian art. They either followed western style or far eastern techniques but they somehow were able to project their own individual style. **Abanindranath Tagore** and his disciples contributed on a large scale. **Nandlal Bose, Jamini Roy, D. P. Roy Chowdhury** and others have left their mark in the history of Indian Art. **Bengal School** provided a starting point to the movement to the contemporary Indian Art. The best and most individualistic painter was probably **Amrita Shergil**. Though she didn't follow any Indian school, she was able to produce a good number of remarkable works within a short period of seven years. The technique, the choice of subjects and the desire to bring forward the true Indian life through their work were well received by the next generation.



TERMINAL EXERCISES

1. Write in brief what kind of art evolved after **Company Art** declined in India?
2. Describe the subjects of **Raja Ravi Verma's** paintings.
3. Describe the composition of the painting "**Brahmacharies**".
4. Write a paragraph on **Gaganendranath Tagore's** style of painting.



Notes



Notes



ANSWERS TO INTEXT QUESTIONS

8.1

1. Oil on canvas.
2. **Damayanti** is listening message from her lover **Nala**, narrated by the swan.
3. Between traditional Indian art and Western realism.
4. Oleograph.

8.2

1. Post-Impressionism
2. Five
3. Horizontal plane with vertical placement of figures.
4. 1938

8.3

1. Sketches of Himalayas, life of Chaitanya
2. Cubism
3. Scenes of Kolkata and the funny side of the life of its citizens.
4. Water colour or paper.

GLOSSARY

Fresco - wall paintings done in tempera, water colours

Mythological - legendary

Revolutionary - innovative

Static - motionless

Solemn - serious

Uniformity - regularity

Vividly - strikingly

Colonial Art - an art form established in British rules in India.

Expressionism - an art through which emotion, feeling, etc. are expressed.



9

CONTEMPORARY INDIAN ART

After the decline of Mughal empire and the end of classical and medieval art of India. Contemporary art began with the British rule in India. **Raja Ravi Varma, Abanindranath Tagore, Amrita Shergil, Rabindra Nath Tagore, and Jamini Roy**, were the pioneers of contemporary Indian Art. These young artists were more exposed to the western art movements. **German Expressionism, Cubism, Fauvism, Dadaism and Surrealism** left great influence on these Indian painters, but at the same time, their struggle to retain Indian identity continued. A combination of western technique and Indian spiritualism became the essence of Indian art at this stage. Along with the western methods and materials, they also tried to use the far eastern methods of painting. Lot of experiments were done with print making (Woodcut, Lithograph, Etching etc.). **Pradosh Das Gupta, Prankrishna Pal, Nirode Mazumder, Paritosh Sen** and others of Calcutta group held the first show in 1943 and the progressive Artists group of Bombay exhibited the paintings of **F.N. Souza, Raza, M.F. Hussain, K.H. Ara** and others in 1947. While some artists were experimenting with western style, others like **Benode Behari Mukherjee, Ramkinkar Vaij, Sailoz Mukherjee**, showed inclination towards **Japanese art and Folk Art**. Two of Bengal School artists, **Devi Prosad Roy Chowdhury** and **Saroda Ukil** played fundamental roles in introducing modern art movement in the Northern and Southern parts of India. **K.C.S. Panikar** and **Srinivasalu**, students of **D.P. Roy choudhury**, made their mark in contemporary Art while **Saroda Ukil** established an Art School in Delhi.

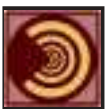

OBJECTIVES

After studying this lesson, the learner will be able to:

- describe the contribution of major art movements of India.

MODULE - 3

*Introduction of Contemporary
Indian Art*



Notes

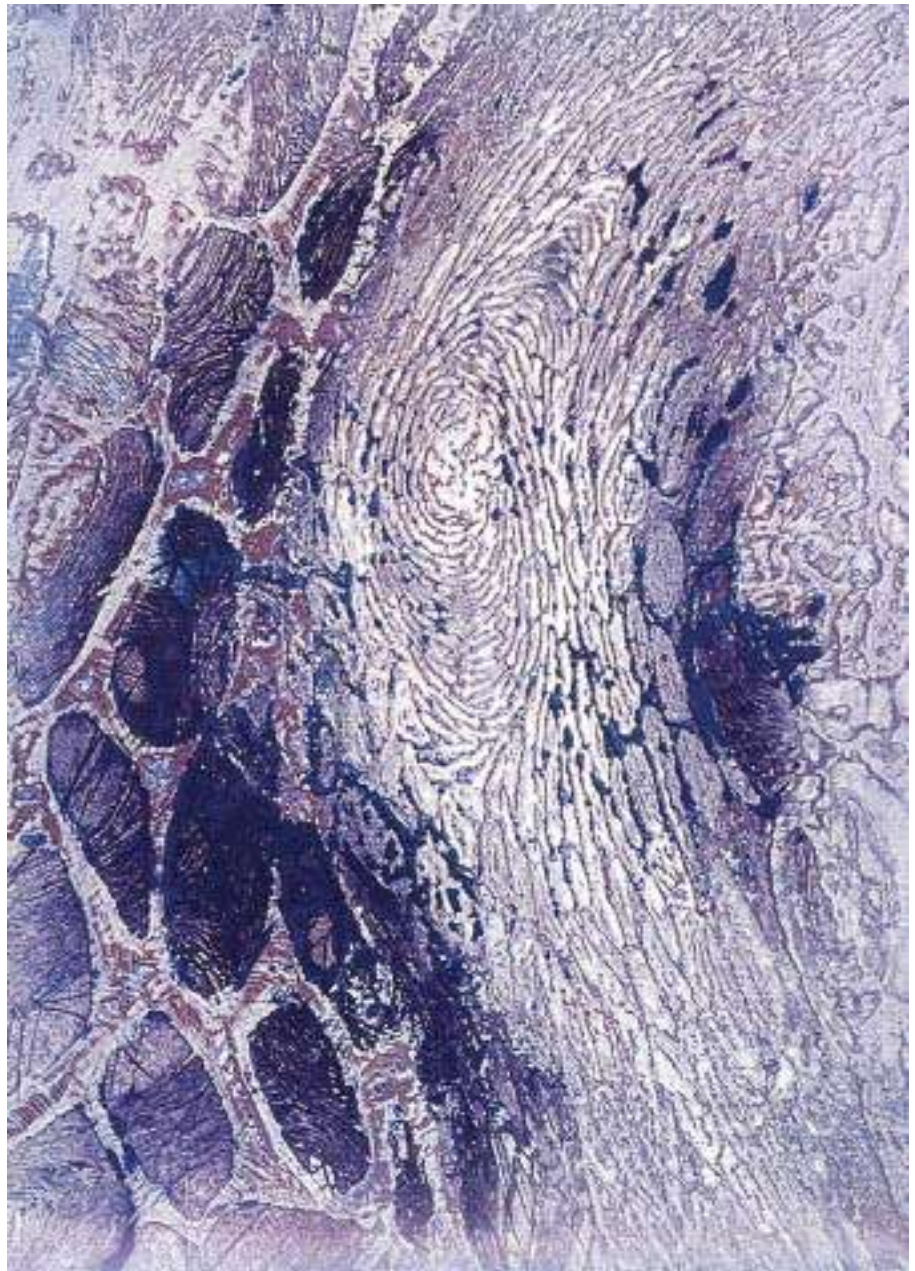

WHIRL POOL

Contemporary Indian Art

- State the name of the artists, who played important role in the development of contemporary Indian art;
- Tell about the methods and materials the contemporary artists used;
- Identify the famous Indian painters of contemporary period;
- Describe in brief the enlisted contemporary artists;
- Write in brief about the enlisted contemporary artists.

9.1 WHIRLPOOL

- Title – **Whirlpool**
- Artist – Krishna Reddy
- Period – 1962
- Size – 37.5cms x 49.5cms
- Medium – Intaglio on paper.

GENERAL DESCRIPTION

Graphics or **Print making** is very popular form of art which are being used by western artists for many centuries. Indian painters took interest in Graphics from the end of 19th Century A.D. Etching, dry point, aquatint, intaglio, lithography, oliography etc are used by many Indian artists. The main advantage of print making is to produce number of copies of the same painting. **Raja Ravi Verma** could popularize his paintings by printing many copies of his works in oliograph technique.

Krishna Reddy is one of the most famous print makers of that time. He was a student of **Kala Bhavan, Visva Bharati, Santiniketan**.

“**Whirlpool**” is one of the masterpieces of **Krishna Reddy**. It is done in intaglio process. This process is reverse of the relief method, because the surface of the plate does not print, as the ink being held only in the engraved furrows. The lines of design are incised in copper or zinc plate. Ink is used on it and then the surface is wiped clean with scraper. After laying a damp paper on it, print is taken by putting pressure in a machine. In “**Whirlpool**”, Reddy creates new forms from known objects and to take the form into abstraction. His main interest in the picture is to capture the force of nature. Everything is lost in the cosmic whirlpool. The images in the picture are non representational though some images like stars, flowers and clouds are not very clearly recognizable. His early experience of sculpturing helps him to understand the relief type intaglio effects in the prints which is the main beauty of this work.

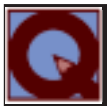

INTEXT QUESTIONS 9.1

1. Name the print making technique artists use.

MODULE - 3

Introduction of Contemporary Indian Art



Notes

MODULE - 3

Introduction of Contemporary Indian Art



Notes



MEDIAEVAL SAINTS

2. Which print making technique has been used by **Krisna Reddy** for “Whirlpool”?
3. What do you know about **Krishna Reddy**’s work “Whirlpool”?

9.2 MEDIAEVAL SAINTS

Title	–	Mediaeval Saints
Artist	–	Benode Behari Mukherjee (1904-1980)
Period	–	1947
Collection	–	Mural on the wall of Hindi Bhavan, Visva Bharati. Santiniketan.
Medium	–	Fresco Buono

GENERAL DESCRIPTION

Benode Behari Mukherjee was a student of **Nandalal Bose**, the famous Bengal School painter. **Benode Behari** loved nature and its beauty and he based his paintings on that. He learnt the art of landscaping from Japan. He used very simple and rational lines like the Japanese artists. These lines have quality of Calligraphy. **Benode Behari** suffered from weak eyesight from his childhood and became totally blind in the later part of his life. Neither his poor eyesight in young age and blindness in later age could stop his creative urge.

All through his life he experimented with different mediums. In spite of his blindness, he created a huge mural at Kala Bhavan, Santiniketan.

“**The Mediaeval Saints**” is one of the murals which he painted on the wall of Hindi Bhavan in “**Fresco Buono**” technique. It is a method of wall painting in which powdered pigments colours are mixed in water and are applied to wet freshly laid lime plaster ground. In this method the colour becomes the part of the wall so that the colours last long.

“**Mediaeval Saints**” is a wall painting (Mural) depicting the Saints of different religions of India. The composition is well planned to suit the size and shape of the walls. The huge and **elongated** forms of the human figures arranged with a river like flowing movement in perfect harmony and rhythm. The monument like quality of these figures remind us of Sculptures on the Grothic Church wall. The emphatic verticality of the composition is nicely balanced by smaller figures in horizontal continuity. The largeness of the figures express their spiritual greatness. The smaller figures represent the common people engaged in different activities of every day life.



MODULE - 3

Introduction of Contemporary Indian Art



Notes

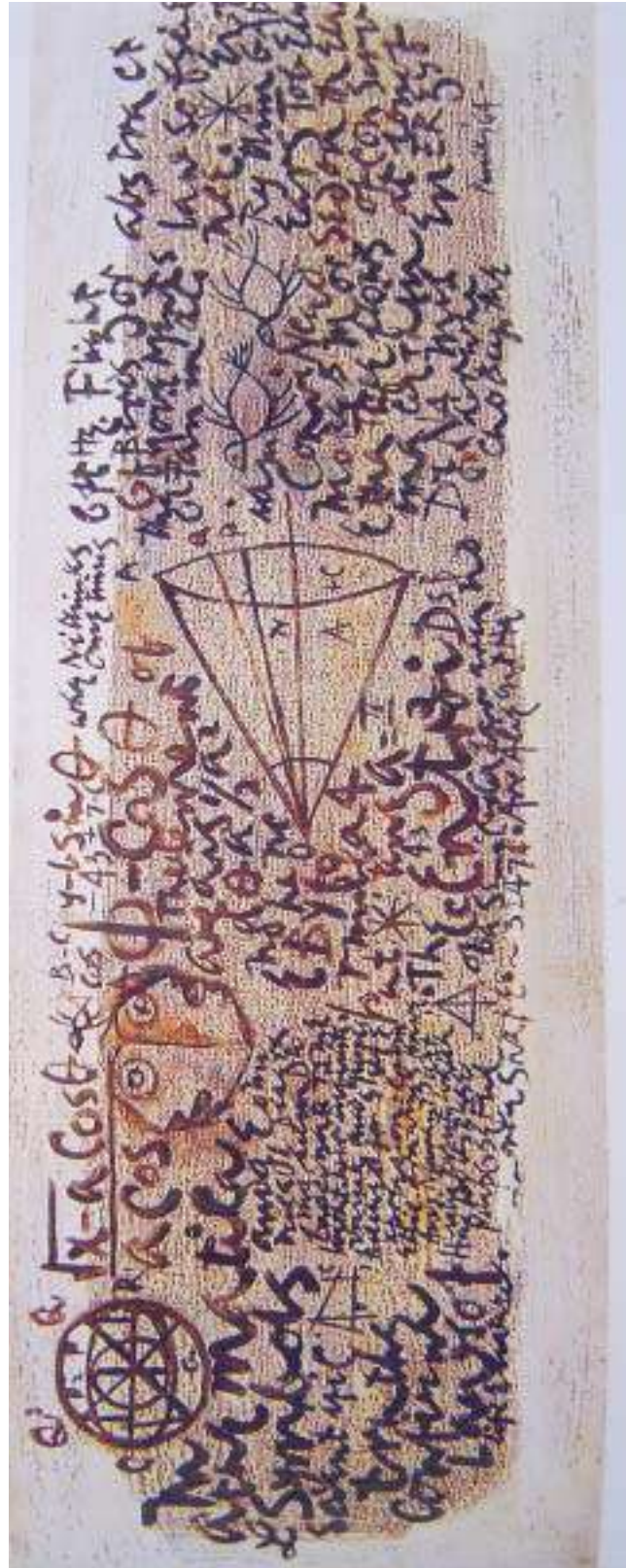

WORDS AND SYMBOLS

Contemporary Indian Art

The lines are very emphatic in this painting but the colours are very limited with brown, yellow ochre and terraverte.



INTEXT QUESTIONS 9.2

1. Write about **Benode Behari's** teacher and his place of education.
2. Write in two lines about the technique of "**Fresco-Buono**".
3. What are the colours, mainly used in "**Mediaeval Saints**" Mural?
4. What was **Benode Behari's** physical problem?

9.3 WORDS AND SYMBOLS

Title	– Words and Symbols.
Artist	– K.C.S. Panikar (1911-1977)
Medium	– Oil on board.
Size	– 43cms x 124cms.
Date	– 1965.

GENERAL DESCRIPTION

K.C.S. Panikar could be termed as the most influential and pioneer in the development of contemporary art movement in the Southern part of India. He was a student of **D.P. Roy Choudhary** of Bengal School in the Madras School of art.

He had to do many odd jobs as a telegraph operator and insurance agent before he could establish himself as an artist. His style went through many stages from realistic to geometric. He was also a great teacher who inspired many painters from south and established the first artist village of India near Chennai named "**Cholamandalam**".

The enlisted painting is a very famous one from his series "**Words**" and "**Symbols**". It is a very different type of experimental work in which space is covered with calligraphy. **Panikar** used mathematical symbols, Arabic figures, Roman Scripts and Malayalam Scripts to create a design which looks like a horoscope. Tantric symbolic diagrams are also used. Colours play a nominal role in this painting.

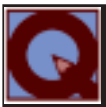

INTEXT QUESTIONS 9.3

1. Mention the role of **K.C.S. Panikar** in the art scene of South India.
2. What is '**Cholamandalam**'? How it is related to Panikar?

MODULE - 3

Introduction of Contemporary Indian Art



Notes

MODULE - 3

Introduction of Contemporary
Indian Art



Notes



LANDSCAPE IN RED

3. Write two lines on enlisted paintings of **Panikar**.

9.4 LANDSCAPE IN RED

Title	– Landscape in Red
Artist	– Francis Newton Souza (1924-2002)
Period	– 1961.
Size	– 78.7 cms X 132.1 cms
Medium	– oil.
Collection	– Jahangir Nicholson Museum.

GENERAL DESCRIPTION

F.N. Souza was born in Goa and grew up in Mumbai. He was expelled from his school and joined J.J. School of art. He was again expelled from J.J. School of Art in 1945. He was one of the young painters to form the “**Progressive Artists Group**” in 1947. Later he left India and settled in London. Subsequently he became one of the five top artists to represent them internationally. His lower middle class background and financial problems made him protest against society. He protested against all kinds of religious and social superstitions through his paintings. Like most of his contemporaries, **Souza** was also inspired by post impressionist and German expressionist painters. Especially he was greatly influenced by **Picasso** and **Matisse**. He discovered his own style by combining Indian temple sculpture forms with western art. He was a painter with relentless experimentation in all forms of art.

Souza had special love for landscape painting along with religious and social themes. The “**Landscape in Red**” is a good example from his landscapes.

It is an experimental cityscape. The artist tried to capture look of a city which is nothing but a concrete jungle. His cityscapes generally reflect the mysterious character of cities. The calligraphic use of lines are nicely arranged with colours. The colours and forms emerge independently in the composition. Red is the predominant colour here with few splashes of green here and there. No rule of perspective is followed. In spite of that the depth of space is clearly defined in the painting.

Souza created many types of works over a long working life. He is compared with **Picasso** by an European art critic for his works.



INTEXT QUESTIONS 9.4

1. Name one of the founders of “**The progressive Artist Group**”.



Notes



2. Write on few important qualities of **Souza's** "The landscape in Red".
3. Who did inspire **Souza's** art?
4. Name the foreign cities **Souza** Stayed.



WHAT YOU HAVE LEARNT

Indian contemporary art, which began with **Raja Ravi Verma** and Bengal School, continued to flourish in different metropolitan cities of India. Western influence became very clear on the young generation in spite of Bengal school's attempt to revive classical tradition of Indian art. The young generation of thirties and forties took inspiration either from the west or far east to give a new meaning to Indian art. Some of these painters went to western countries and ultimately settled there and those stayed back were struggling to discover their identity. It is heartening that many of these painters not only found their identity, but also could establish themselves as internationally successful painters.



TERMINAL EXERCISE

1. Describe the influences that helped in the development of contemporary art of India.
2. Write about two painters of India who settled abroad and became famous.
3. What do you know about the Indian painter who became blind?
4. Write in brief about the Artist-**Souza**.
5. Describe in brief of **Panikar's** one of the famous paintings.



ANSWERS TO INTEXT QUESTIONS

- 9.2**
1. Dry point, Aquatint, Intaglio
 2. Intaglio
 3. **Krishna Reddy's** main interest in the picture is to capture the force of nature. Every thing is lost in the cosmic whirlpool. The images in the picture are abstract forms of stars, flowers and clouds.

9.3

1. His teacher was **Nandlal Bose**, a famous Bengal School painter.

Contemporary Indian Art

2. It is a method in which powdered pigments are mixed in water and are applied to a wet freshly laid lime plaster ground.
3. Brown, yellow ochre, Terraverte.
4. He suffered from weak sight and became blind.

9.4

1. He was most influential and pioneer in the development of contemporary art movement in south.
2. He established the first artist village of India near Chennai named “**Cholamandalam**”
3. “**Words and Symbols**” is an experimental work in which space is covered with calligraphy.

9.5

1. **F. N. Souza**
2. Experimental cityscape vision of mysterious world, calligraph, no conventional perspective.
3. **Picasso** and **Matisse**
4. London, New York.

GLOSSARY

- **German expressionism** – An Art movement of 20th Century by painters like **Kandinsky, Kirchner, Nolde** etc.
- **Cubism** – A form of Art in which objects are simplified in basic geometrical shapes. Main artists are **Picasso, Braque, Leger** etc.
- **Fauvism** – A style of painting in which very warm and loud colours are used. Main artist is **Matisse**.
- **Surrealism** – In this style of painting very realistic forms are combined in an unrealistic manner, as it happens in dream. Main artists are **Dali, Chirico** and others.
- **Calligraphy** – Art of script writing.
- **Gothic period** – A Christian Art and Architectural style of 13th Century A.D.
- **Horoscope** – Diagram showing the relative position of planets and zodiac signs for use in calculating births foretelling event in a person’s life. It is a part of Astrology.

MODULE - 3

Introduction of Contemporary Indian Art



Notes



1

OBJECT STUDY

Man has created several objects which we use in everyday life to satisfy our needs. Of all these, certain objects such as books, boxes, utensils are easily available.

The art involved in painting such objects, as they look, is known as **Object-Study**. It is advised that the learner should repeatedly draw the pictures of the objects in which he is interested.

**OBJECTIVES**

After studying and practicing this lesson, the learner will be able to:

- learn about the perspective of the objects;
- discriminate between shadow and light;
- show the measurement of the shape of the objects and its proportion distinctly;
- use the colours appropriately in the painting.

A student should have the following things for an object study:

1. A drawing board or hand board
2. Drawing paper (cartridge paper)
3. Drawing pin.
4. Pencil (HB, 2B, 4B, 6B)
5. Eraser



Notes

6. Colours
7. Brush
8. Colour mixing palette

Several other things such as a book, box, pots, fruits and other household goods are needed for making a model.

Perspective

Perspective is most essential element in the process of object study. It is therefore essential that the student should be able to draw the object on the paper exactly as he observes (perceives) it.

What is perspective? To the viewer (artist) every piece of the object set in serial order appears to be reduced in size as it goes to distant position as has been shown in Fig. 1. When a number of objects, like bottle or box of same size are put in a line they appear to be meeting at some point.

Similarly, the rule of the perspective is applicable to every object which we draw irrespective of its shape or size.

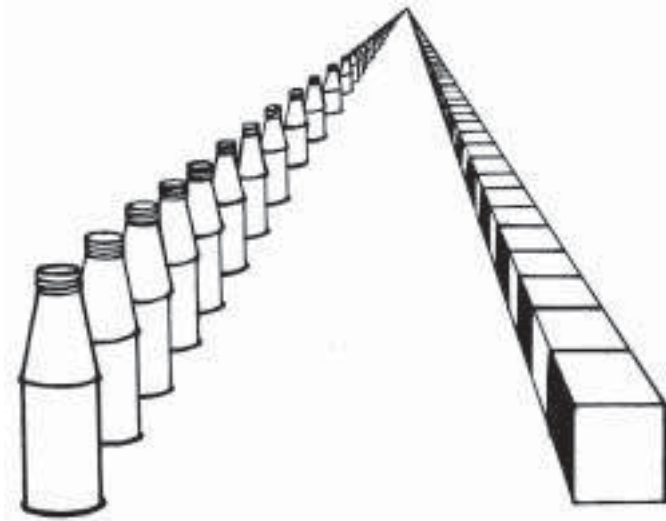

Fig. no. 1

Light and Shade

When light falls on any object it shows the effect of shadow and light. The lighted part looks bright and the other portion becomes dark (shadow). This can be ascertained by looking at the object with half-closed eyes.

This shadow and light is expressed by tone. They are of three types: (i) bright as light (ii) medium light (iii) deep shadow. The effect of light and shade is different on

square and round object. A square object is plane. As a result, the light or shadow on each plane side is in square form. On square object, light and shade is marked sharply, on the contrary on round object, tone merges gradually from-dark to light. See figure No. 2. We, therefore, can paint any object very well after we have seen the object in reality.

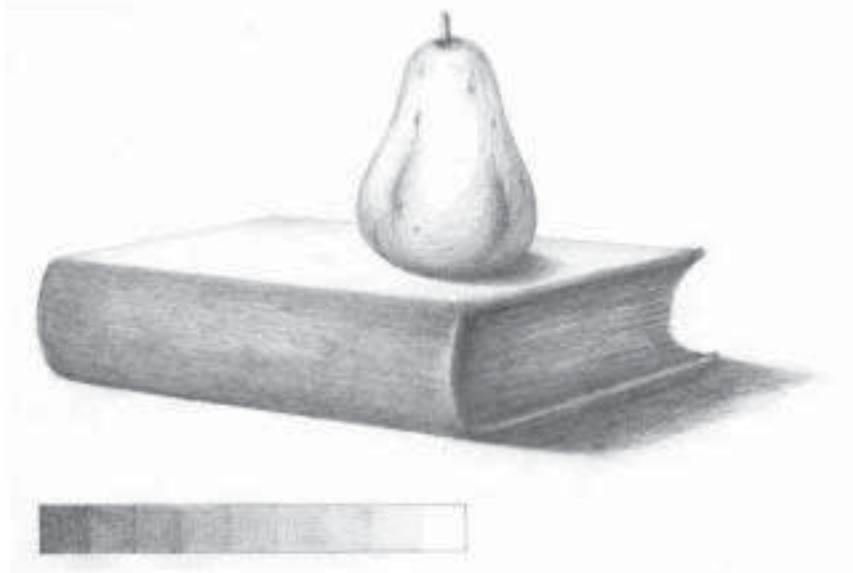

Fig. no. 2

Different tones of light and shade can be shown by pencil. Better to use HB, 2B, 4B, 6B pencils. Shade can be shown by either more or less pressure on pencil. This will ensure different tones.

Measurement and proportion

It is important that the student has idea of right size, measurement and proportion. Every object has a particular length, breadth and height. If we have this idea of the proportion of length, width and height of each object, we can know whether the object is big, small or equal in length, breadth and height. Any object can be drawn even without any measurement or after measuring the object. (Relative height, length and breadth is necessary for drawing any object to show bigger or smaller).

Sit straight to draw the object. Close one eye, stretch your hand exactly in the line of the shoulder and measure the object. Hold the pencil in such a way that the thumb could move to left and right, up to down easily.

If you have to measure length or breadth, hold the pencil in a horizontally but straight position and bring to the left side of the object. Now, move the thumb to the right side and reach out to the right edge of the object. Now, to scale (measure) the height of the object, place the pencil at the upper edge of the object and bring the thumb to the lower edge. Now, mark the measurement on the paper. You can, now,



Notes



Notes

project the length, breadth and height either twice or thrice or as per the size of the paper and complete the figure as per the measurement. (see fig. 3).

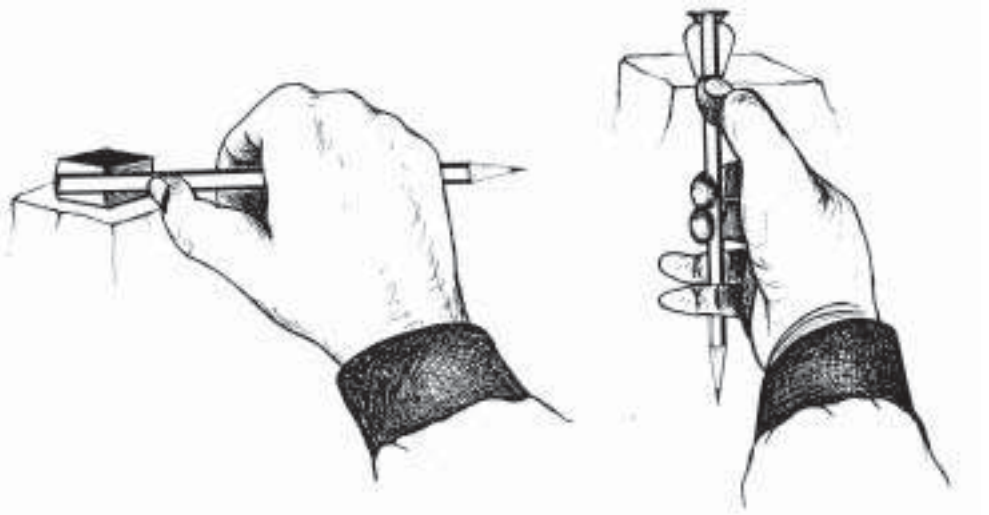

Fig. no. 3

Colour Scheme and Using Colours

A student should use water colours to begin his exercise of painting. Paintings look lively and real after the use of colour. There are various tones of the colour in the shadow and light. The lighted portion looks bright and the shadowed portion looks darker. The red colour gives impression of orange shade, dark red or grey red. Blue colour becomes sky blue, dark etc. in the shadow, likewise the green colour turns into dark green and parrot green due to the effect of light and shade. Various other colours and tones can be achieved by mixing these colours. Light colours should be used to let the object look bright. Dark and foggy colours should be used to show distance and shade. Fig. no. 4. shows such combinations.



Fig. no. 4

Process of drawing a picture

First of all the student should draw rectangular objects such as a book, box and round shaped objects such as a glass or fruits or vegetables. Keep the object below the eye level at some distance on a surface. It is better to hang a cloth as a backdrop of contrasting colour.

Now, set the drawing paper on the drawing board with clips. Look at the model placed opposite to you with full concentration. Now, set the drawing board horizontally or vertically according to the length, breadth and height of the model. Sit straight while drawing the object. Don't change the position till you have finished the drawing.

For example: You are sketching a box with a glass on the top surface of it. First of all, mark and draw the nearest corner point (B) of the lower level of the box on the drawing paper at the right point and draw the baseline see fig. no. 5. From this point (B), draw the lines forming angles with the lines towards the right and left form and mark the length and breath. These are points (A) and (C) respectively. Now, draw perpendicular (a straight line) from point (B) and mark the height at point (E). Now draw a parallel line (B&C) to (A&B) from the point ~~E~~ towards the right. see fig no. 5.1.

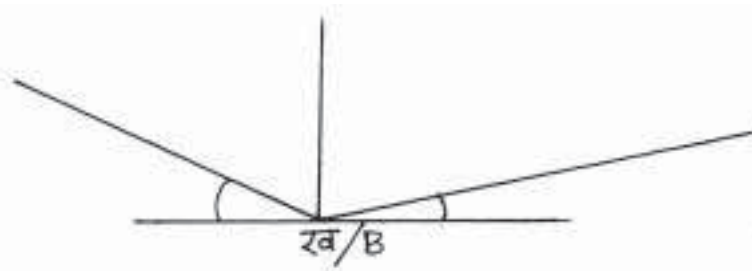

Fig. no. 5

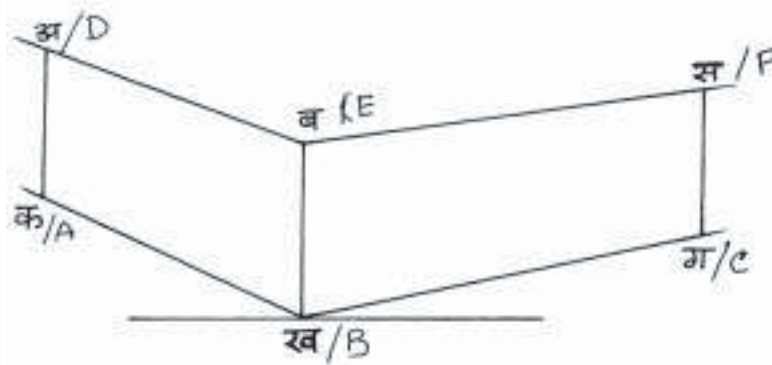

Fig. no. 5.1



Notes



Notes

Now, draw perpendiculars from point A and C which would meet on points D and F. In this manner we'll get the length and breadth of the box. Now, to draw the upper layer, draw parallel lines from point D to E and another parallel line from point F to E. When these two lines meet, the upper part of the box is formed. The students in this way can draw the shape of the box. See figure No. 5.2.

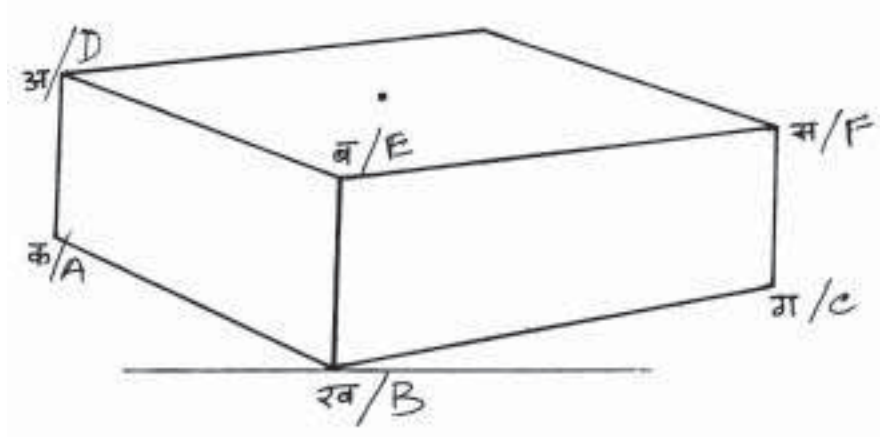

Fig. no. 5.2

Now, draw the picture of the glass kept on the upper part of the box. The method to draw a glass is shown in Fig. 5.3.

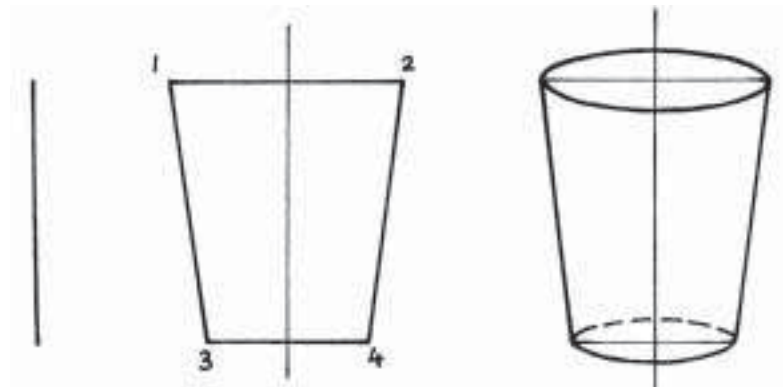

Fig. no. 5.3

Object Study

Measure the centre point of the lower level of the glass kept on the upper level. Draw a perpendicular from the point and mark the height of the glass. Draw parallel line from these two points. Now mark the breadth of the upper and lower level from point 1, 2, 3 and 4. Later join points 1-3 and 2-4 as per the parameter of the top of the glass. This will enable the student to draw outline sketch of the glass.

Use oval shape to draw the top and bottom of the glass. Mark two points (5 and 6) at the central line and make them meet. Use similar method to draw the bottom of the glass. You may use the pencil shade or colours to complete the drawing of the object. See figure no. 5.4.

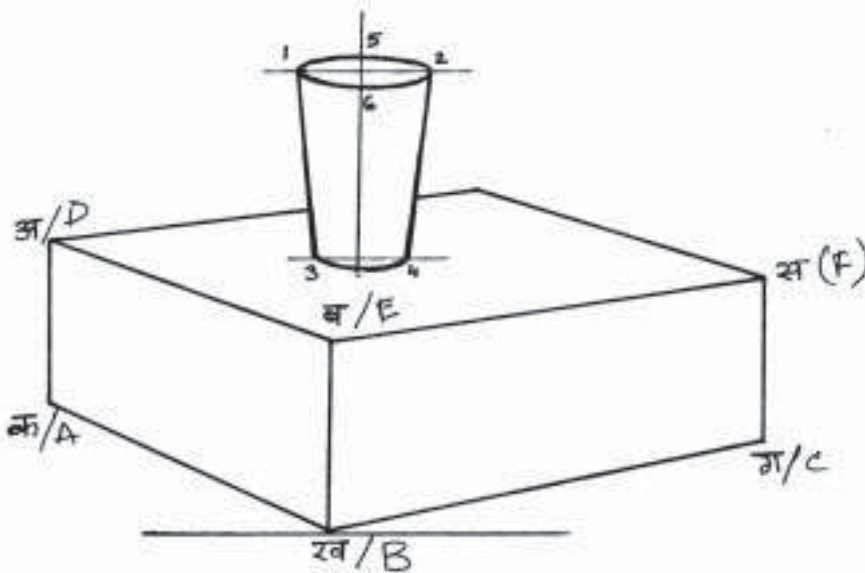

Fig. no. 5.4

Summary

A student can draw an object if he regularly practises. This will generate confidence and maturity.

Light and Shade help the artist to discriminate between the rectangular and round-shaped objects. Similarly, colour combination of the picture emerges as beautiful and lively.

Painting Practical



Notes



Notes

MODEL QUESTIONS

1. Draw a picture of a book. Keep the book as a model in front of you.
2. Draw a picture of a brick and a round shaped pot. Use pencil to shade the object's drawing to show light and shade effects.
3. Keep two fruits and a knife on a plate and draw these. Complete it with appropriate colours.
4. Draw a picture of a few bread slices put in disorder (just dumped).
5. Lay an earthen pot beside a canister. Colour the picture drawn.



STILL LIFE
By Ara



STILL LIFE WITH FLOWERS (Oil on Canvas)
By Van Gogh



2

NATURE STUDY

Since time immemorial nature and man have been seen closely linked. Nature has always inspired man to survive. Besides, it has made people to realize its beauty. Man is the only living being who has high and developed sense of appreciation of beauty. He has, therefore, taken up nature after deeper study to immortalize it. Sculpture and Painting have been effectively used to immortalise nature's beauty. Its mountains, rivers, oceans, flora and fauna in different shapes and colours often attract man.

Life exists in all forms of nature. Nature has movement and expresses diverse feelings and emotions through colours, shapes and texture of nature. A beautiful picture emerges if all such components are kept in mind.

Following factors are essential while depicting nature:

(i) Perspective (ii) Balance, (iii) Composition (iv) Harmony, and (v) Colours.

They are used proportionately in all arts. This is possible only if practised regularly.



OBJECTIVES

After studying and practicing this lesson, the learner will be able to:

- draw pictures of various natural objects;
- compose various natural things in picture form;
- use water colours harmoniously in the composition; and
- draw pictures keeping the balance in mind.



Notes

Perspective

We should take special care of perspective while doing nature study. It is important to maintain balance of vanishing point under the rules of perspective. It is possible only if we paint the objects in proportionate size. It should look big if it is closer and similarly smaller if it is distant. The detail of the object should be shown in the painting. Tone should be marked by showing the distant object smaller and painted in faint colours. For example, the tree which is closer is shown thicker and big one. Similarly, the path to the hut and its roof is proportional to other close objects. In this picture the portion in front of roof has been painted proportionately bigger to portion at a distance. The hillocks at the rear look small. In brief in nature study all efforts should be made to incorporate perspective, balance, composition and harmony. Any thing missing would affect adversely.

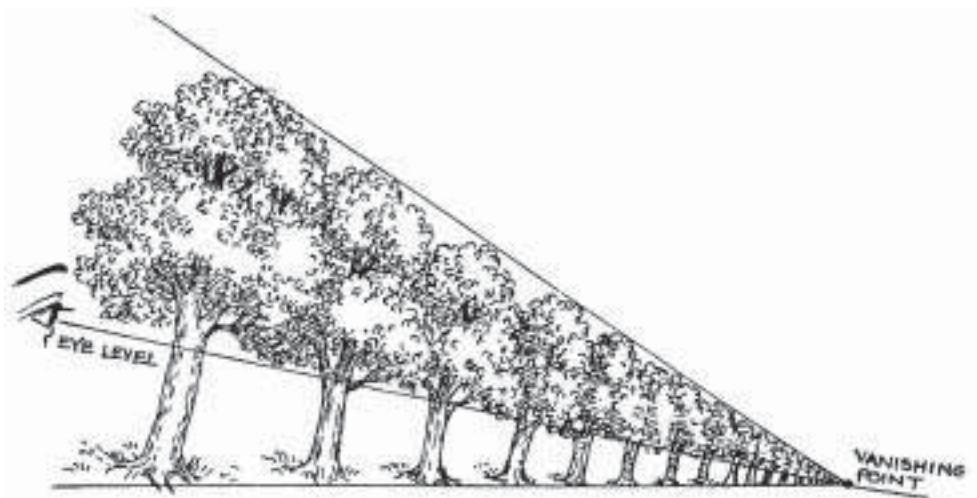

Fig. 1

Balance

Balance plays a vital role in drawing a picture. While painting, the space on the paper should be arranged in such a manner that every aspect of the painting is

balanced. In case, in a painting one side of the paper has thick forest and the other side is occupied by herbs and shrubs or a bungalow, it will look absurd and it will not be a balanced painting. (Fig. 2 and 3) Space on the paper should be balanced.



Fig. 2



Fig. 3

Composition

One should take care of perspective, balance and harmony to compose a picture of nature. The elements and objects in the painting should be composed beautifully. Composition is significant in nature study. See figure no. 4 which is a faulty composition but Fig. no. 5 is well composed and also balanced.



Notes



Notes



Fig. 4



Fig. 5

Harmony

The objects and forms in a composition should be arranged in such a way that can establish a relationship which will bring the harmony in the painting. The colours play an important part to achieve harmony. Perfect and balanced use of colours can bring the relationship between rhythm and harmony. See fig. no. 6.



Fig. 6

Colour

It is important to be cautious while using water colours. The student should at the outset, use light colours followed by medium, dark and later darkest. To let the near objects look nearer, it is important to use bright colours such as red, yellow, orange. For distant objects cool colours such as blue, violet and brown etc., should be used. Note the use of colours in different steps to paint flowers and landscape in Fig. no. 7 and 8.

Step-1



Step-2



Fig. no. 7



Notes



Notes

Step-3



Step-4



Fig. no. 7

Step-1



Step-2



Fig. no. 8

Step-3



Step-4



Fig. no. 8

Summary

Sketches are significant while making nature study. It needs right perspective and proportion to be a good painting. Perspective facilitates in bringing depth in the space in the picture. As per the rules of the perspective, the objects in the foreground will look bigger than the objects in the background. The parallel lines appear to meet at a point as they move to the horizon. Dark and light lines can also be used to show the nearness and distance and also distance of the objects. It is important to mind composition, balance and harmony while painting nature.

Try to capture the real colours of Nature in your painting. Some minor changes can be made to enhance the beauty. This permits slight variation in brightness by reducing or increasing the brightness.

MODEL QUESTIONS

1. Draw a balanced sketch of a tree or a plant.
2. Draw a balanced picture of nature with a hut and a tree. Use water colour.
3. Draw a sketch of fruit, flower and a flower vase. Use water colour on it.



Notes



Notes

4. First draw separate sketch of a mountain, coconut trees, stone and sea at separate places. Later draw two different compositions based on these sketches. Fill in the pictures with poster colours.
5. Go to any nearby garden and draw sketches of different flowers.
6. Based on perspective, paint the petals of some flowers using water colours to colour the leaves.



MALLARD AT THE WATER'S EDGE

By Archibald Thor Burn

(Water Colour)



DRAWING

By Gopal Ghose

(Water Colour + Brush)



Notes

3

HUMAN AND ANIMAL FIGURES

We see innumerable living beings roaming on earth, water and in air. They are either male or female. Consequently, they are physiologically different.

On close observation, we find beauty, delicacy, beautiful body shape and flexibility in the physique of every living being. The structure of every living being is proportionate. This facilitates normal movement and their ability to perform their routine easily.

Man is the best of all living beings. That's why man has superior emotions. The artist also expresses those super emotions through his paintings.

Students of art should keep all these facts in mind while exercising paintings.



OBJECTIVES

After studying and practicing this lesson, the learner will be able to:

- get the required information about structure, measurement and proportion of the living beings;
- draw simple sketches with lines;
- sketch human and animal figure; and
- draw human structure of any measurement.

Necessary equipments/stationery

- Thick cardboard or drawing board
- Drawing paper (chart paper or cartridge paper)



Notes

- Pencil HB, 2B, 4B, 6B
- Eraser
- Colour
- Brush etc.

Human Structure, Measurement and Proportion

Human as well as animal body is made of bones, muscles and skin. It undergoes changes from childhood time to old age. It is, therefore, necessary to have all information about all the organs.

Normally, human body (from head to toes) is divided into $7\frac{1}{2}$ parts. The top most part of the body (head to chin) is one part. The whole body is measured on the basis on this unit. Followings are the measurement of the body:

- (a) Head to Naval - 3 units
- (b) Naval to Knee - 2 units
- (ii) Knee to feet - 2 "
- (iii) Width of feet - $\frac{1}{2}$ "

Besides this division, the face has also been divided into 4 units— ● 1st unit:- Head and hair ● 2nd unit: forehead; ● 3rd unit : Nose and ● 4th unit : nose to below chin.

The full length of the arm is divided into $3\frac{1}{2}$ units as follows:

- Shoulder to elbow : $1\frac{1}{2}$ units
- Lower arm : $1\frac{1}{2}$ units
- Hand : $\frac{1}{2}$ unit

This width of the two shoulders should be 2 units. The length of the foot should be 1 unit. This measurement facilitates drawing the human structure (see fig. no. 1).

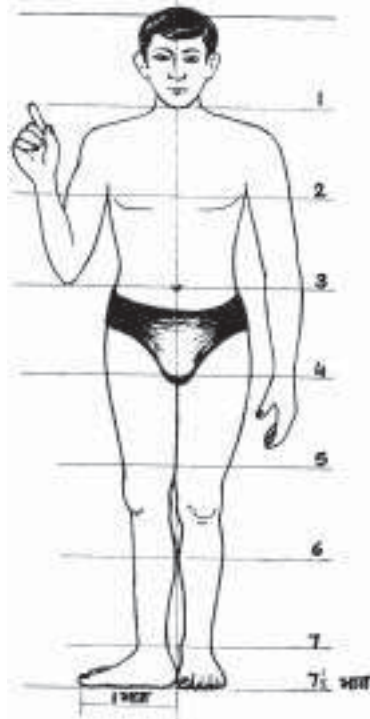

Fig. no. 1

Straight line Sketching

Sketching with straight lines is called straight line sketching. Straight line sketching works as skeleton in human body. Straight line sketching is important in drawing the entire human structure and animal structure.

Students can draw the sketch of any size/measurement either by adding or reducing. The form can be adjusted according to the size of the paper. (Fig. 2)

Making Sketches

Sketching means using lines after scanning the objects/people and also using imagination. Use dark pencil (4B, 6B) for this purpose.

Since human being and animals are moving constantly one should observe these movements and try to capture the movements in lines. The artist has to depend on his memory and perception to depict it in drawing. This activity will need exceptional coordination of wrist and fingers. Increase the speed of use of lines.

Human and Animal Figures

Sketching and straight line sketching are very important in drawing the human and animal figures. A student would become competent to draw these figures effectively if practiced regularly.



Notes



Notes

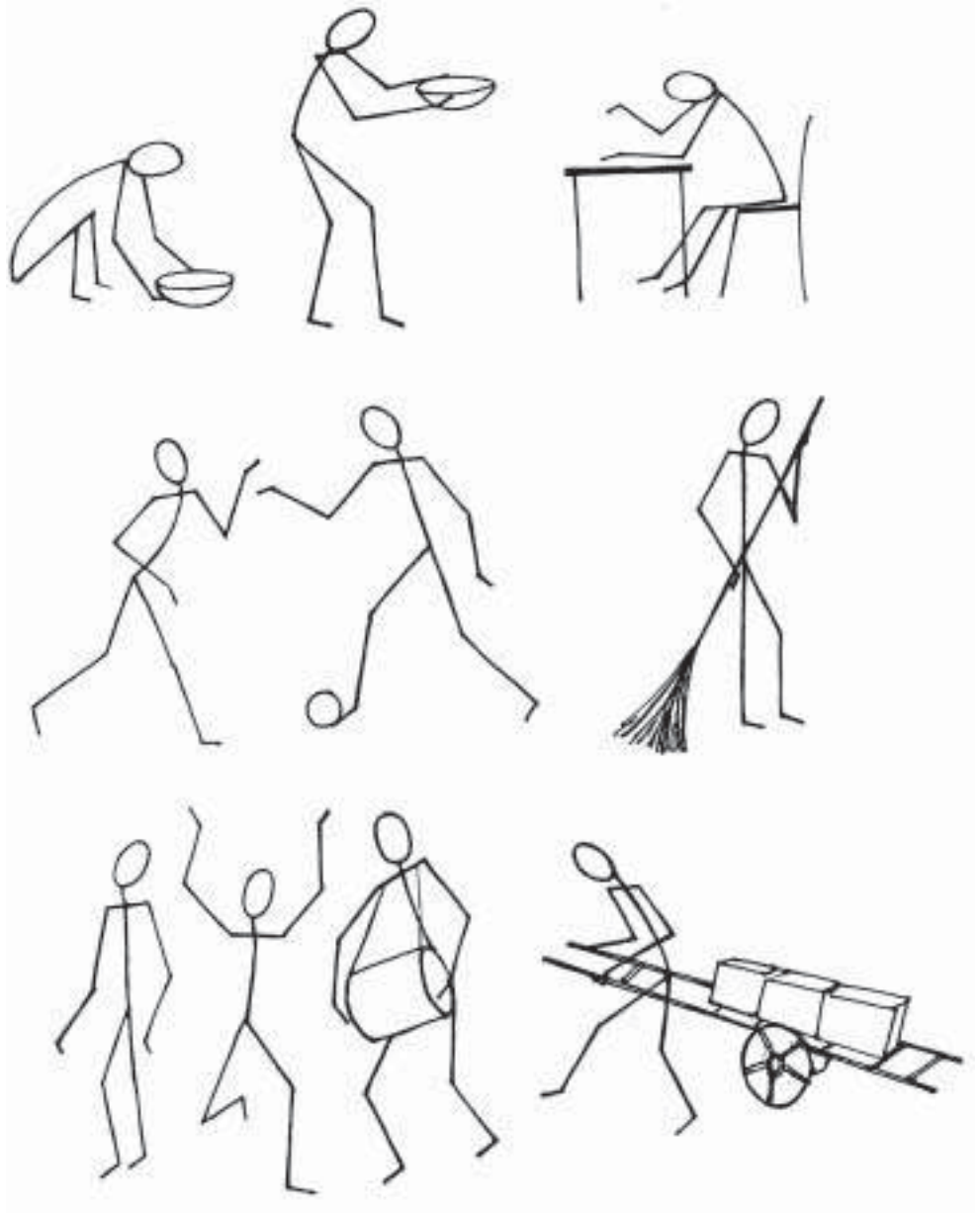

Fig. no. 2

Fig. 3 explains how to draw a horse. At the first stage it is the straight line sketch in which a skeleton like picture has been drawn with the help of certain lines or circles. At the second stage it has been provided to form the body of the horse, (face and feet etc.) Later, at the end, muscles and all other parts of the body have been formed with minutest details. Thus, the picture of the horse can be completed with pencil shade or colours. See Fig. No. 4 and 5.



Notes

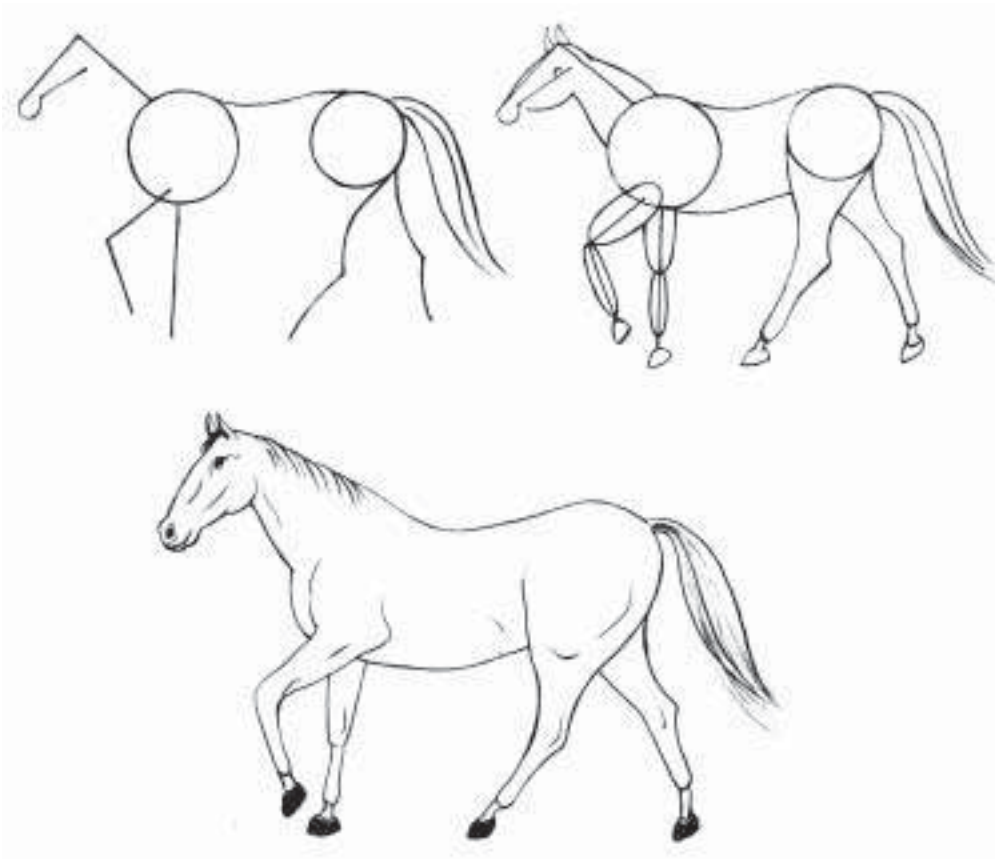

Fig. no. 3



Notes

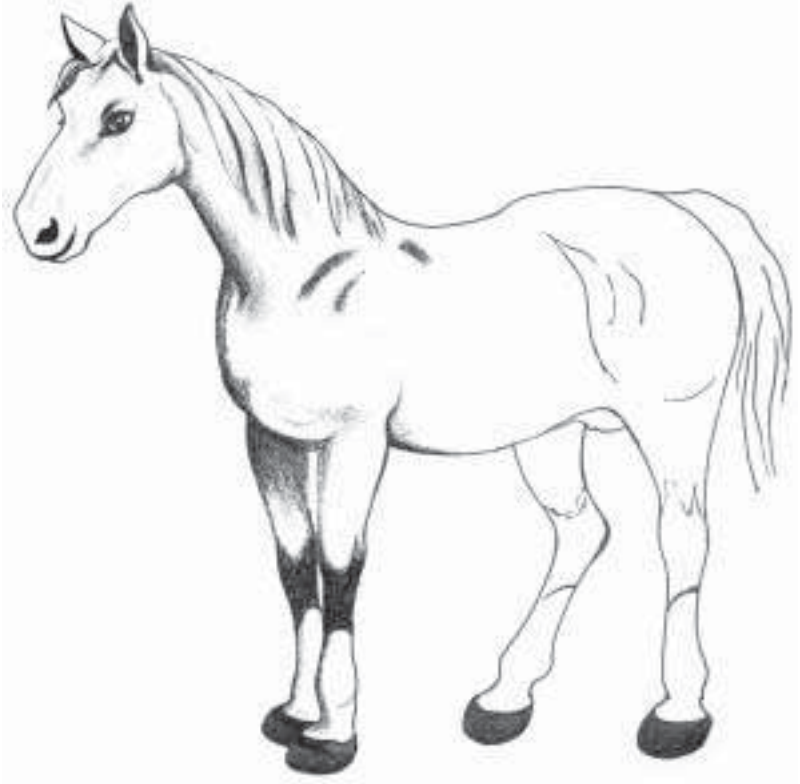

Fig. no.4

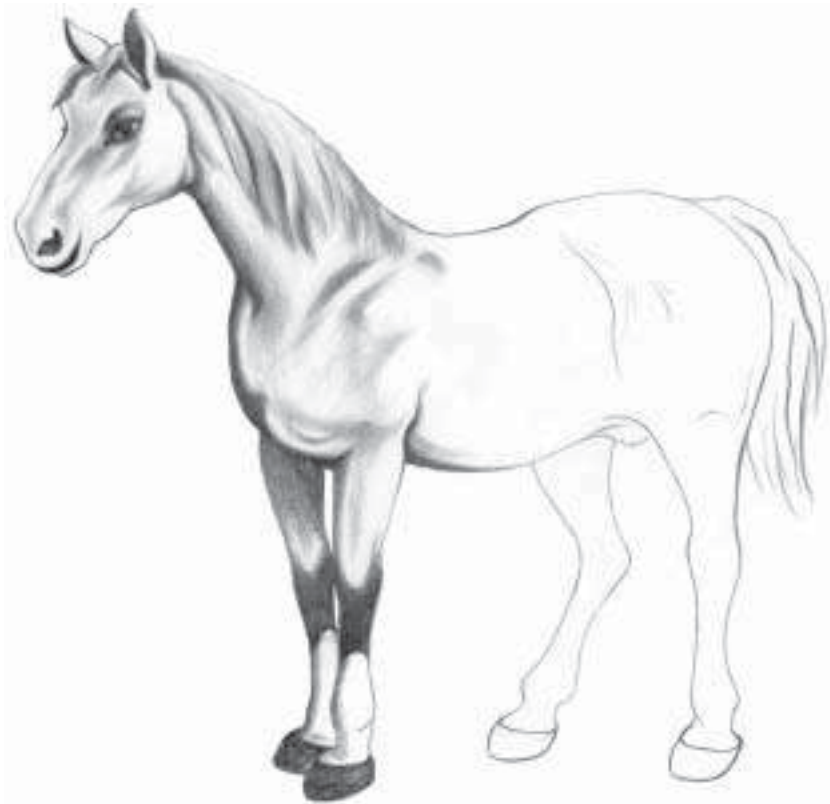

Fig. no.5



Fig. no. 6

While drawing human figure similar steps and precautions have to be taken. Any shape/structure can be made even by sketching. See Fig. No. 6. The student can ask somebody to sit in front of him/her according to his convenience. Observe the position of the model before he starts sketching. He should keep the measurement in mind. He should measure the face in relation to entire body.

He can make a composition with two/three human figures. See Fig. no. 7.



Notes



Notes



Fig. no. 7

Summary

The artist paints to express human emotions such as happiness, anger, anguish, peace, innocence and beauty. The student should try to express all such emotions to make the piece of art complete in itself.

Animal structure is different from the human figures/structures. Therefore, he should portray similar shape and structure. He can become a better artist if he regularly practises.

MODEL QUESTIONS

1. Draw a figure of a horse and complete by shading it with pencil.
2. Draw any pet animal.
3. Draw human figures likes those of members of your family or friends.
4. Draw a human figure as per measurements.



Notes



INDIAN DANCER
By K.K. Hebbar



Notes



CAT
By Ram Gopal



4

COMPOSITION

Any composition is an expression of emotions and feelings of the artist emerging out of the inner most layer of the heart. Such feelings are expressed through colour, lines, shape etc. They all are employed in such a manner that an expressive composition is created. In such compositions everything needs to be in proper balance, rhythm and harmony. The composition becomes imbalanced if any of these essential elements is dropped. This necessitates harmonic communion of all shapes. Composition, therefore, means the appropriate use of essential elements in the process of painting.



OBJECTIVES

After studying and practicing this lesson the learner will be able to:

- i) learn to place 2-3 or more than these objects on one piece of paper in systematic manner;
- ii) create different shapes effectively in producing a composition;
- iii) show light and shade effectively with pencil;
- iv) sketch based on the imagination, outline for the composition;
- v) select the subject for painting effectively; and
- vi) use the colours appropriately in painting.

Geometrical Forms of Composition

The composition in which geometrical figures have been used is called Geometrical composition. Take a simple plain paper to make a composition. Cut it in the shape of 10"x10" or 10"x15" or use your own imagination to draw a shape with pencil



Notes

and scale, on the paper, in agreement with the concept of imagination. Inside this picture, draw shapes in the form of circles, rectangles and triangular. Later on fill in the colours to make a composition. You may also use black or dark coloured papers cut in different shapes and decorate them on the paper you want to make a composition. This will facilitate you to know basics of composition and you will be able to make a composition easily.

Remember, the composition should be harmonious and balanced irrespective of the medium you use. It may be water colour or poster colours (see fig. nos. 1, 2, 3 and 4).



Fig. no. 1



Fig. no. 2



Fig. no.3



Fig. no.4



Notes



Notes

Conceptual composition

Such a composition is based on the student's imaginative power. The imagination is rooted in the worldwide experiences of life.

It is important to decide the subject matter before the composition is initiated.

It all depends on the student's choice of the subject matter. It may vary from fisherman, road side dhaba, fair, rain, railway station to bus stop. Firstly, draw 4-5 composition based on your choicest subject. Later, enlarge one of the best composition you have made either on the paper or any other material.

Composition may be vertical or horizontal. It depends on the artist's choice. It is important to note that all components used in the composition are related to each other. It is also important to note that withdrawal of any component would affect the entire composition. Every composition has a central focal point. It should be an obvious point in the entire composition. Every good composition has balance, harmony and rhythm. See Fig. No. 5 and 6. Two birds are composed on a tree branch with harmony and balance. After line drawings, the composition is coloured. Such a combination would make the composition attractive and complete.

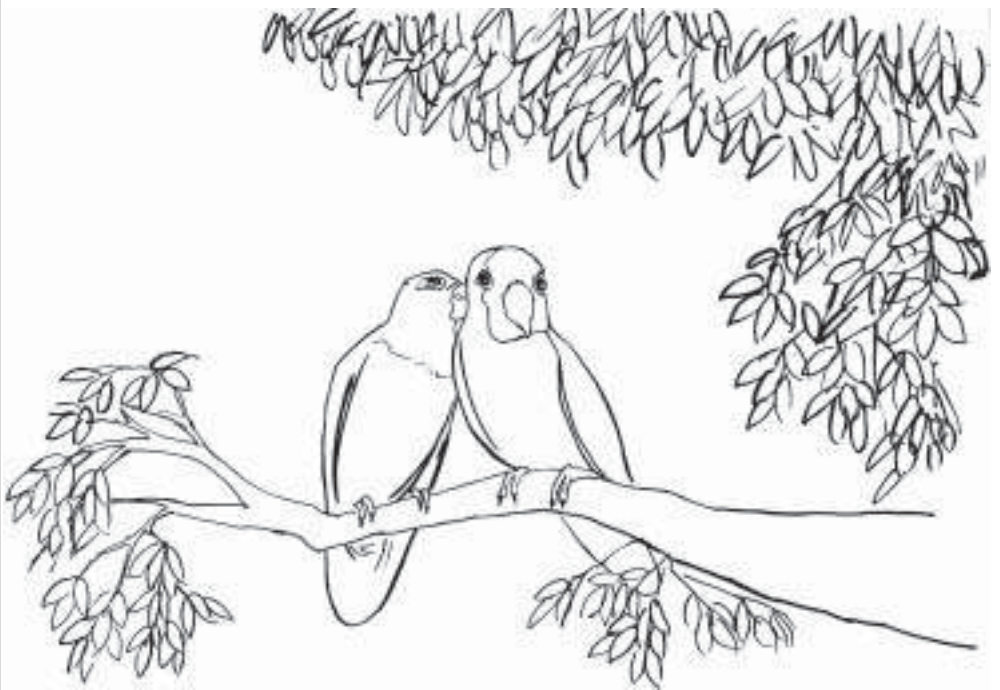

Fig. no. 5



Fig. no. 6

Composition with Object

Following component are used for a composition:

- | | |
|--------------|----------------|
| 1. Jug | 8. flower vase |
| 2. Cup-plate | 8. Vegetables |
| 3. Bread | 10. Stove |
| 4. Egg | 11. Bucket |
| 5. Knife | 12. Pan |
| 6. Fruit | 13. Basket |
| 7. Book | 14. Bottle |



Notes



Notes

**Fig. no. 7**

Select a few of these and set on an even platform. Hang a curtain in the background. Choose the items according to the choice of the object. It is presumed that the student is wise enough to decide the size of the object. Firstly, draw one or two object with pencil and show light and shade. (See Fig. No. 7). Use of colour should follow it. Balance, harmony and rhythm are essential for composition. (See Fig. No. 8). You can select some vegetables and arrange on a table with a coloured cloth in the back ground. Draw and colour it (see Fig. No. 9).



Notes



Fig. no. 8

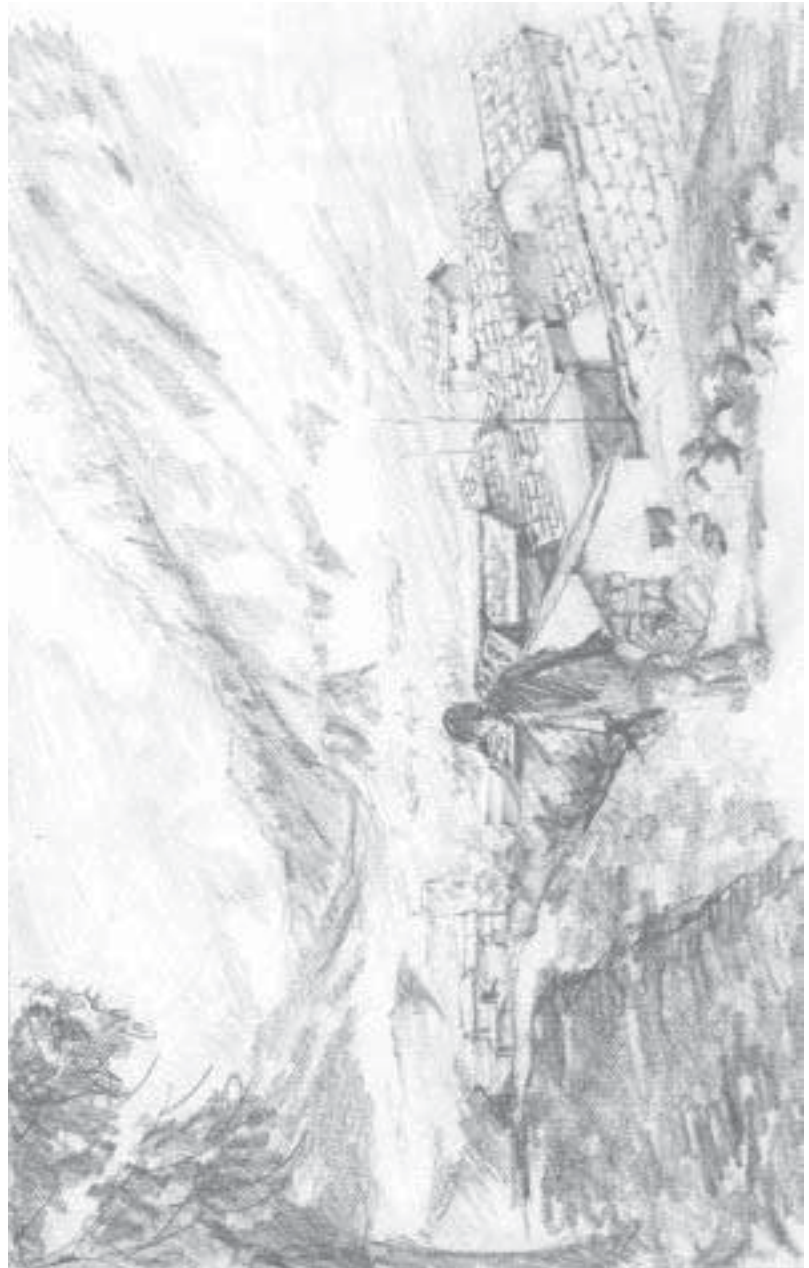

Fig. no. 9

**Notes****Composition Based on Nature**

One can use villages, cities, mountains, rivers and canals to draw nature based composition. Normally horizontal scene is used in nature based composition.

For example : choose any scene. Anything and every thing seen in nature can be used for composition, Focal point is a must component in composition. See fig. no. 10. Before colours are used in the composition, it is suggested that the composition be made with a pencil. Mark the space of light and shade with pencil. The viewer can have clear picture (idea) of light and shade in the composition.

**Fig. no. 10**

Now colours can be used in the composition. Decide and mark the spaces for high, medium and low tone of colours. Balance of colours is essential. Harmony and rhythm are the signs of good composition. See Fig. No. 11.



Fig. no. 11

Decorative Form of Composition

Draw sketches of natural objects such as flowers, leaves, trees, creepers, birds, bees, butterflies, squirrels etc. Give different shapes and designs to these sketches and compose them with several ornamental shapes. That would look different from any other composition. A good composition has balance, rhythm and harmony. Use of colours should also be harmonious. See the figure 12, 13, 14 and 15.



Notes



Notes



Fig. no. 12



Fig. no. 13



Notes



Fig. no. 14



Fig. no. 15



Notes

Necessary items for composition

For picture composition a student should have the following items:

1. Drawing board, 2. Thick cardboard, 3. White drawing sheet, 4. Chartridge paper, 5. Board pins, 6. Pencil HB, 2B, 4B, 6B, 7. eraser, 8. cutters, 9. brush, 10. colour palette, and 11. mug etc.

Use of colours in composition

In Water-colour technique, begin with-light colour and then use dark tones. Apply out-two layers of light colours and then apply medium and dark colours. This will make the colours evident. Shadow can also be shown in this type of colour combination (see fig. no. 16).



Fig. no. 16

Summary

Composition means assembly of all essential components and their use. In object drawing, exact picturisation of the object is essential. All components should be arranged in such a manner that object drawing is possible. While composition are based on the artists imagination, he can use his own composition and also use colours of his choice. While composing nature, one has to compose what he sees in the company of the nature. We might add or delete some of the scenes/objects.

But this demands vast experience and exposure. Scene-composition demands appropriate use of colours.

In decorative form of composition we draw pictures/figures as we like and use colours as per our choice. Composition should have balanced colours for a perfect composition.

MODEL QUESTIONS

1. Draw a sketch of jug, cup, plate, flower vase and make a composition of all these.
2. Compose geometrical form with black and white papers in circular, triangular, rectangular shapes.
3. Based on your imagination, make a composition of any subject.
4. Paint a landscape showing the beauty of nature.
5. Sketch Flowers, leaves, squirrel, butterflies and compose a design.
6. Use colour on the drawing given below.



Fig. no. 17



Notes



Notes

GLOSSARY

Harmonic Communion – Communicated with harmony

Vertical – Standing position

Horizontal – Reclining position

Withdrawal – Taken off

Presume – Imagined

Ornamental – Decorative



Notes



END OF JOURNEY
By Abanindranath Tagore
(Wash Painting)



Notes

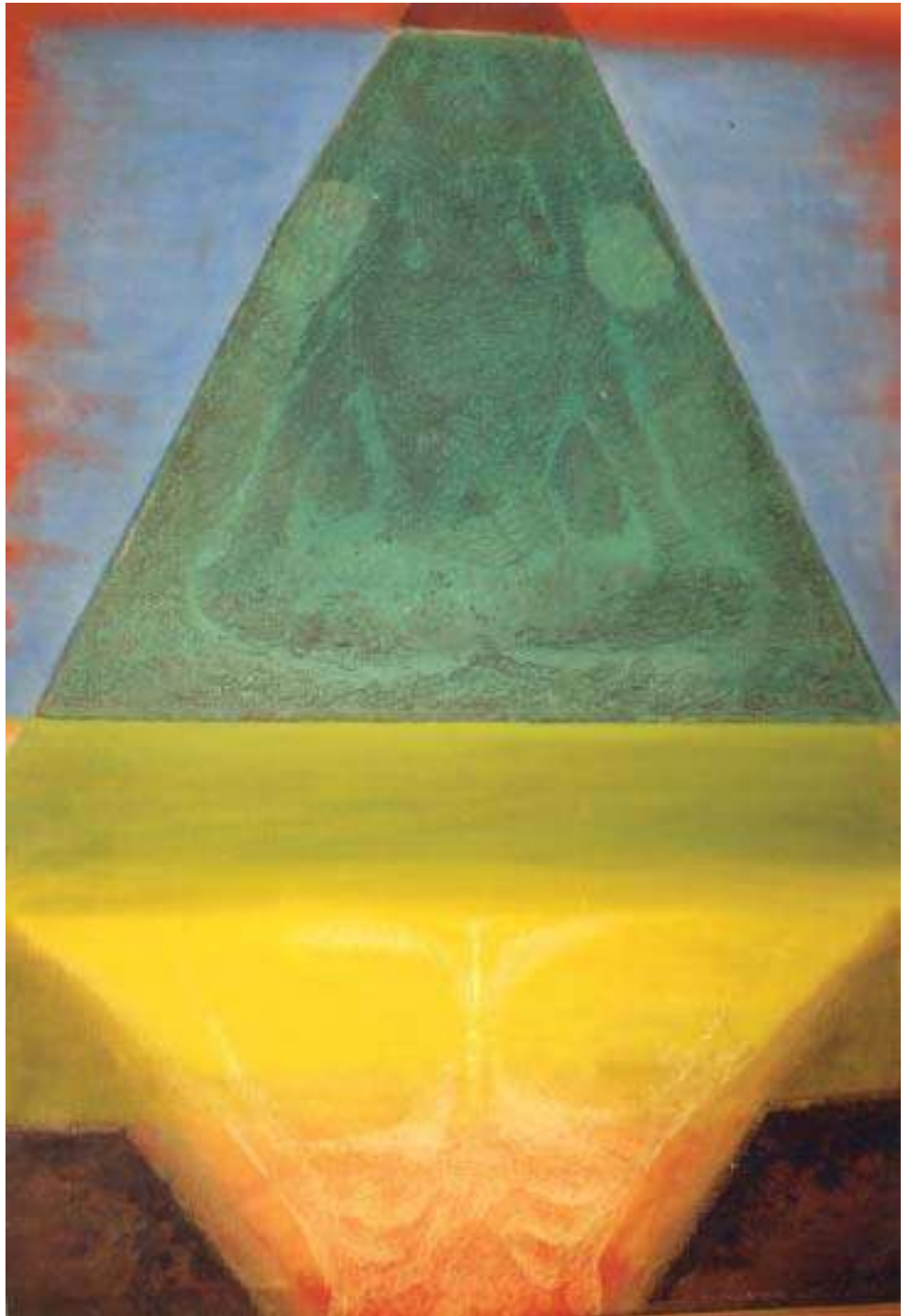

RAVANANU GRAHAMURTI
(Oil)



Notes

1

TOOLS AND MATERIAL

AIM:

To get acquainted to various tools and materials in drawing and painting.

INTRODUCTION

In drawing and painting, it is absolutely necessary to know about appropriate tools and materials. The artist should select these tools and materials according to the work he/she wishes to start. For Sketches and Drawings one should choose softer pencils (B, 2B, 4B, 6B) and for finished and precised drawing, it is better to use harder pencil (HB and H). Choosing colours are also very important. One has to experiment with different colours and medium. Ultimately he would feel comfortable in a particular medium which he can pursue. In this chapter an attempt has been made to give an elaborate and comprehensive introduction to painting and drawing.



OBJECTIVE

On completion of this practical exercise, you will be able to :

- recognize different qualities of pencils and inks;
- select a suitable surface of drawing and painting;
- apply proper brushes (round and flat) accordingly;
- identify the different types of colours applicable in different mediums.



Notes

Uses of Materials:

- Pencils - Hard and Soft, graphite, coloured
- Crayons - Black
- Pastels - Dry, Wax, Oil
- Charcoal - Black
- Paper - Different weight and surface, Cartridge Handmade, Ivory, Chaksy, Pastel.
- Colour - Water Colour (Transparent, opaque), gouache, oil paper
Suitable surfaces for water colours are: hand made paper, chaksy, Cartridge, silk, hard board, wall surfaces.
- Brushes - Kinds of brushes–
 - (i) round brushes for water based colour (ii) flat brushes for oil colours (iii) knife and (iv) spatula
- **Know your tools and materials**

Tools:-

Pencils, HB, 2B, 4B and 6B



Fig. No.1

Coloured pencils



Fig. No.2

Tools and Material

Crayon



Fig. No.3

Charcoal



Fig No.4

Round water colour brushes
No.1, 5, 8 and 12



Fig No.5

Flat Brush for oil colour
No 1,2,4,5,10,12



Fig No.6

Practical Guidelines (Secondary Level)



Notes



Notes

Knife or spatula



Fig No.7

Pallete for water colour



Fig No.8

Pallete for oil colour with oil pots



Fig No.9

Colour material

Water colours



Fig No.10

Poster colours



Fig No.11

Oil colours



Fig No.12

Acrylic colours



Fig No.13



Notes



Notes

Pastel colours



Fig No.14

Coloured ink



Fig No.15

Following are the examples of line qualities of some drawing tools

Line effect of HB pencil



Fig No.16

Line effect of softer pencil like 6B to less soft pencil 4B and 2B



Fig No.17

Hatched line in Pen and Ink



Fig No. 18

Simple line in Pen and Ink



Fig No. 19

With stippling (Dots) you can bring different tones



Fig No. 20

Charcoal blend easily and may be used for modelled renderings.



Fig No.21



Notes



Notes

Crayon can be employed for quick sketches.
Coloured pencils are useful for drawing to add texture.



Fig No.22



Fig No.23

Pastels are often used for portraits, life drawing and landscape.



Fig No.24

- Practice sketches and drawing with the help of above mentioned tools and materials.
- Sketch with pencil. Use both 4B and HB like it is done in this animal figure.



Fig No.25

Tools and Material

Pen and ink or black Jel Pen are excellent medium for drawing and sketching. You try all three techniques like, lines, hatching, and stippling. Remember, you can not erase the ink, so do a preliminary structure in pencil before you use ink.

- Draw anything with straight lines after you start with pencil drawing



Fig No.26

- Draw a human figure or animal figure in hatching technique



Fig No.27

Practical Guidelines

(Secondary Level)



Notes



Notes

- Now use stippling or dots to bring tone in your drawing.



Fig No.28

- Use all the three techniques of drawing in pen and ink. You can make a landscape. Use dark lines in the foreground and light broken lines in the back ground to achieve depth.



Fig No.29

Tools and Material

There are various types of colour materials for painting. Some are traditional and few have been invented in recent times like acrylic.

- Water colours are of many types. Hence you can use transparent water colours. Use lot of water to dilute the colour. Use the previous drawing (Fig. No. 30) and colour it.



Fig No.30

- Now use opaque water colour. Poster colour and gouache, are opaque colours. Take easily available poster colour. Paint the same picture with this.



Fig No.31



- Acrylic is as good as poster colour. You can dilute this colour with water and oil both. It is waterproof. You should use canvas or oil paper.

Fig No.32

Practical Guidelines

(Secondary Level)



Notes



Notes

- For a change you can use spatula-or knife instead of brush. Better you use poster, acrylic or oil. Spatula brings texture in your picture



Fig No.33

- Pastel colours are like pencils, but softer and brighter. Draw colourful objects with it.



Fig No.34

- Oil colours are used on canvas or oil paper. Turpentine and linseed oil are used to dilute it (thinner). See lesson No.3 and the figures. No. 22 to 25.



2

OBJECT STUDY

AIM

To learn the drawing and painting of man made objects in terms of volume, perspective and shading.

INTRODUCTION

In any art work the total perception of art work is very important. An artist can achieve this perception only through constant studies of this object. It is very important to study the manmade objects keeping it in front of him. So the shape, contour and volume are to be studied both with lines and colours. He is supposed to follow some basic steps like perceiving the objects in terms of simple geometrical shapes and he can bring the volume by adding colour and shades. This exercise will help him to perceive the texture, proportion and volume of the manmade objects.

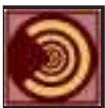

OBJECTIVE

On completion of this practical exercise you will be able to:

- differentiate between difference in basic shapes of objects;
- draw the perceived objects with all its real appearance.
- apply the proportion perspective, colour, texture, light and shade on the objects.

Draw three basic shapes with pencil or ink.

For Example :- Circle (1) Square (2) Triangle (3)



Notes

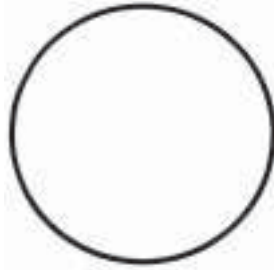

Fig. 1
(1)



Fig. 2
(2)

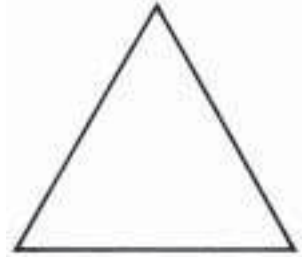

Fig. 3
(3)

You can draw any round objects with circle.

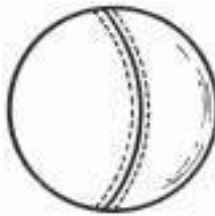

Fig. 4



Fig. 5



Fig. 6



Fig. 7

You can draw any square & rectangular objects with square.



Fig. 8



Fig. 9

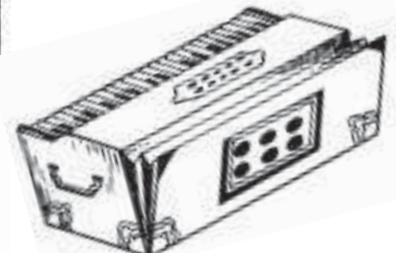

Fig. 10

Object Study

You can draw any triangular objects with triangle.



Fig. 11



Fig. 12



Fig. 13

You can make these pictures in light and shade with pencil or transparent water colour as well as with oil pastels.



Fig. 14

Light and Shade



Fig. 15

Water colour



Fig. 16

Water colour



Fig. 17

Oil pastel

Before you start still life (object drawing) in pen and ink, decide which kind of linear shading you will give to get the effect of light and shade.



Fig. 18

Practical Guidelines

(Secondary Level)



Notes



Notes

Shows an object done by dots also called stippling method. The entire form, light and shade is achieved by dots. Draw the object very faintly with your pencil to get the correct shape.

The areas where there is dark, bring the dots very close to each other almost looking like black patches. Gradually move to the middle tone where dots are not so close to each other. The high lighted areas can be achieved by putting dots away from each other almost like a blank space.



Fig. 19

Shows the object done by straight horizontal lines. The entire form and effect of light and shade is achieved by short and quick horizontal strokes.

Draw the object first with faint lines with your pencil to get the basic shape. Then with your pen bring the horizontal strokes (lines) closer to each other for the darkest areas. The high lighted areas can be left blank.



Fig. 20

Shows the objects done by criss-cross lines. This is called hatching. Here the lines are taken in diagonal strokes over-lapping with each other. Lines are brought closer to each other to get the darkest areas and for highlighted areas space is left blank.



Fig. 21

Objects composition with colour pencil

Exercises :

- (1) Draw three basic shapes with the pencils free hand in different sizes without the help of any instruments.
- (2) Draw any objects like Watermelon, Orange, Apple with the help of circle and complete in light and shade with pencil.
- (3) Draw any Triangular object like hut, icecream, cone, flower vase and fill in pastel colour.
- (4) Draw Table, Television or lunch box and complete with water colour.



Notes



NATURE STUDY

AIM

To be able to capture the essence of Nature which is ever changing, in terms of light, shade and colour.

INTRODUCTION

Nature study consists primarily of trees, flowers, foliage, mountains, rivers, sea, etc. While doing nature studies we must understand the basic difference between object drawing and nature. Nature is ever changing and full of life. So it is necessary to capture this essence of nature according to ones perception. It is very important to keep in mind the perspective, balance, composition, harmony and colour, which are to be used according to ones desired study.



OBJECTIVE

On completion of this practical lesson, you will be able to:

- differentiate between the man made objects (still) and nature (life);
- identify oneself with nature and its surroundings;
- distinguish colour texture, forms of natural things;
- draw and paint landscapes with correct colour, perspective and natural light.

Study the Nature

Start with small natural objects like fruits, vegetables, foliage and flowers

STEP: I

Place two apples in front of you. Draw the outlines.



Notes

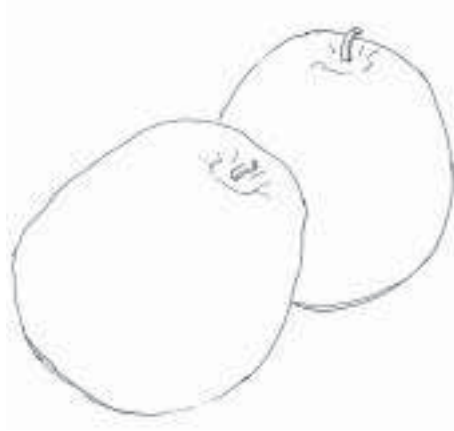

Fig No.1

STEP: II

Colour it with thick poster colour. Use crimson, Lemon yellow and green colour.



Fig No.2

- Select some common vegetables (cabbage, brinjal, bitter gourd etc.) and draw in pencil, (use 2B or 4B pencil).



Fig. No. 3

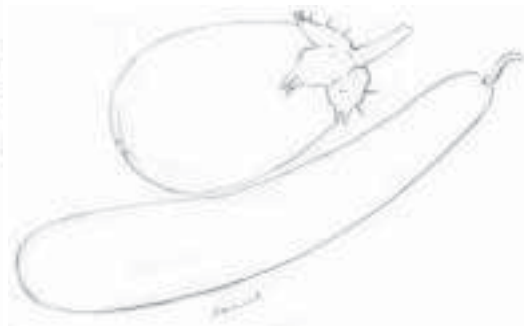

Fig. No. 4



Notes

- Choose one vegetable (like Shalgam) turnip. Draw with HB pencil and then use black water colour with brush No.8



Fig No.5

- Now take few vegetables of same kind (as capsicum here). Arrange it properly. Use coloured pencils. (Viridian green, sap green, and chrome yellow pencils are used).



Fig. No. 6

- Try the same composition in different medium. Poster colour is a good option. (Poster green, chrome yellow and white colours are used).



Fig. No. 7

Nature Study

- Select different kinds of vegetables like Red chili, Cauliflower, Karela (Bitter gourd) Draw outlines with black water proof ink pen. Then use coloured ink or water colour.



Fig No.8



Fig No.9



Fig No. 10

- Try your hand in transparent water colour. Arrange some onions. Draw with HB pencil. Use crimson and burnt Sienna adding lot of water in colour. Restrict yourself to use only one layer of colour.



Fig. No. 11

Take a bunch of flowers. Make a study of these flowers with HB pencil. Draw the outline of the flower.

STEP:I



Fig No. 12

Practical Guidelines

(Secondary Level)



Notes



Notes



Fig No. 13

Now paint the flowers. Use chrome yellow, yellow ochre for the flowers. Dark green and light green (mixing white and lemon yellow) for the stems.

STEP: III



Fig No. 14



Fig No. 15

- Paint the background with contrasting colours and the flower with yellow colours. In this painting the background is of red and blue poster colours.

STEP : II

- Paint flowers in transparent water colour. Do not use details, give only suggestion of forms.

- Study a plant with pen and ink. Draw the compositional structure with HB pencil and finish with pen. Be careful when you draw the leaves in the back ground and foreground, these should not overlap each other.



Fig No. 16



- You can try oil colour on canvas for the composition of flowers and plants. You can add few other elements to enhance the beauty of the picture.

Fig No. 17

- Trees have different characteristics. Trees also play a very important role in landscapes. Try to capture the texture, rhythm and character of these trees in your sketch. You can use pen, pencil, crayon and pastel. This is done in black pen with hatching.



Fig No. 18



Notes



Notes

- Study trees with transparent water colour. Make it very simple. Avoid detailing. Use limited colours. Only blue, lemon yellow and brown colours are used in this picture.



Fig No. 19

- Landscape painting should be done on the spot. Choose a location. It is not necessary to travel far to find one. You can select any spot you like. Sea beach is very attractive and pictorial. Begin with sketch with pencil. HB and 2B pencils are used here.



Fig No. 20

- Try your hand in acrylic colour, Unlike oil colour it dries quickly. You can use Fevicryl (these are inexpensive) on oil paper. Use the same drawing as in figure 20.



Fig No. 21

- You can do the same composition in oil colour on canvas or oil paper.

STEP: I

Draw only the outlines of your sketch on oil paper or canvas



Fig No. 22

STEP: II

Fill the drawn areas with dark colours. The oil colours are different from water colour. Begin with dark colours in shadowed areas then move to lighter tones.



Fig No. 23

- Put lighter tone for detailing. The hill, boats, bushes, steps and building have many shadowed areas.

STEP: III



Fig No. 24

(Secondary Level)



Notes



Notes

- Finish the painting with white and other very light colours

STEP IV



Fig No. 25

Exercises:

1. Arrange few bananas on a table and draw these with pencil.
2. Find a pot of plants with large leaves. After finishing drawing, colour it with poster colours.
3. Visit a nearby park. Choose a row of big trees. Draw these trees. Take care of perspective. Now use water colours.
4. Take a photograph of hill station or sea beach. Try to copy it with pencil. Choose any medium of colour and paint it.



Notes



Light House (Water colour)
by Homer

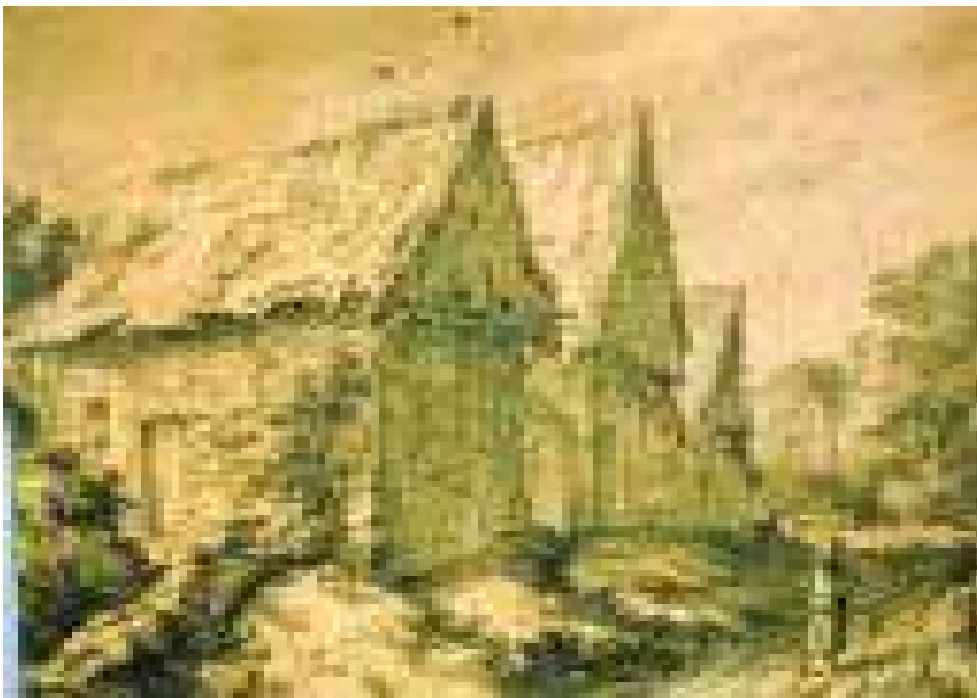

Three Half timbered Houses
by Ruisedael



HUMAN FIGURE

AIM

The study of Human figure concerns in capturing the different characters and emotional expressions. Both of these could be achieved with gestures and body languages.

INTRODUCTION

Human being is probably the only creature who can express all kinds of emotions in many ways. It is a real challenge for an artist to capture these emotions in human being. Apart from vocal sound, human being expresses all these emotions through different gestures, postures and movements of the body, eyes, lips and eye brows. The other factor which is important to keep in mind for an artist is to capture the different physical characteristics of the human figure. A student would learn the different body languages of a human form expressing different kinds of emotions through practice of sketching. Paintings are mainly a vehicle of communication of various expressions. A learner should try to use human form to express such emotions and moods.



OBJECTIVE

On completion of this Practical exercise, you will be able to:

- draw human figures with proportion;
- express the correct mood and feelings of the human figure;
- depict all kinds of expressions through movement, gestures and postures of the human body.



Notes

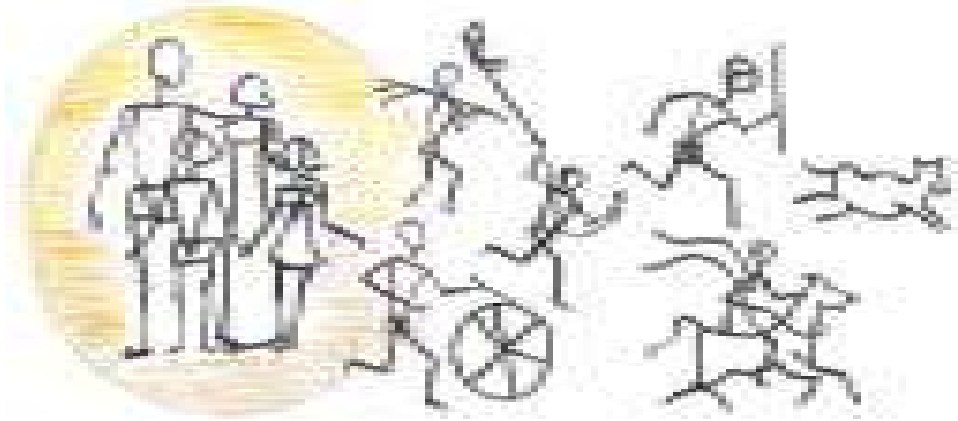

Fig. 1

Draw human forms in simplified line-drawing as shown in frame-1. Try to express action like walking, writing, running, playing or riding by moving the suggestive arms and legs attached to its body. Drawing in frame -1 is done with crayon, but you may draw them with pencil or chalk.



Fig. 2

Fig. 3

Add details to line - drawing in simplified blocks drawing which could indicate posture, volume and forms of human figure. For reference see fig. 2. Drawings in fig. 2 are done with HB pencil and later, with ink-pen. Try to compose more figures of your choice as suggested in fig. 3.

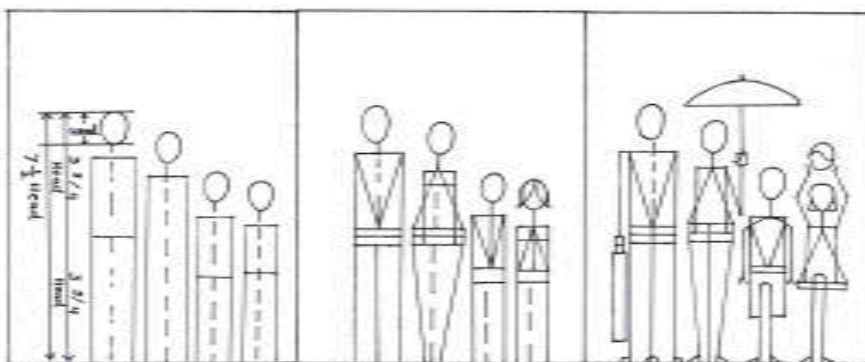

Fig. 4



Notes

Learn some of the basic principle of human form adding geometrical elements to it (see fig. 4). If we take the height of one head as one unit, remember an average proportion of an adult erect body height is 7.5 head or 7.5 units. With children the proportion stands as 6.5, 6 or even lesser units to it head varying according to it's age as shown in fig 4A. Male torso has almost a parallel waist and bust line, while female torso has a board hip line than the bust line as shown with triangle and rectangle blocks in fig 4B. Compose the family with simplified human forms, as framed in fig 4C. Drawing in frame 4 are done with HB pencil and later, with ink-pen.



Fig. 5

To draw foot, recognise the triangle and rectangle block structure, and then add fingers to it, as shown in fig 5: At beginning, place your own foot in the centre of a paper and draw the outer contour to understand the basic drawing of your foot. One may also develop the foot drawing watching your own foot prints carefully. Practise the front view, side view, twist and turns observing the mirror image of your own foot or sketching from life models. Drawing in fig. 5 are done with pen and ink, 2B and 6B pencils.

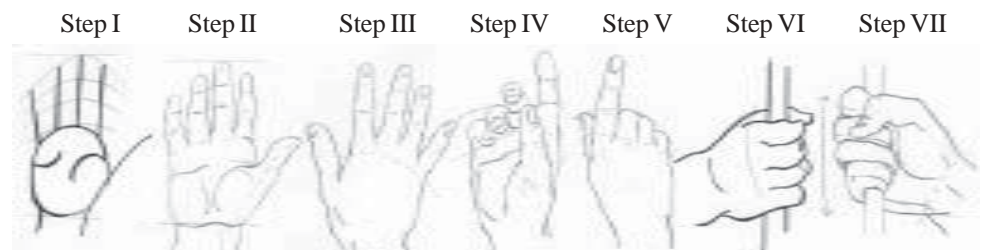

Fig. 6

To draw hand and fingers, draw a circle, attach imaginary lines as fingers and thumb shown is step (I), Fig. 6. Add details to the line drawing to get the frontal view of the palm, see-step (II). Follow step (III) to get proportion of hand with its back view.

Human Figure

Try to draw hand with folding of its fingers, both from front and back view, follow and observe step IV, V, VI and VII for reference. Drawing in frame-6 are done with pen and ink, 2B, and 6B pencils.



Fig. 7

Study a standing figure carefully. Let the figure lean upon and get supported by something to stand. The distribution of the weight of the body is put on legs as shown in fig. 7. Observe turn of the torso, hip line and head. Knowledge of actual bone structure helps to construct solid block drawings. For the figure (See 7A). One must model character of human figure in attachments of blocks with round. Finally one may add details defining the form and rendering it further with drapery as shown in fig. (7B). Drawing in fig. 7 are done with 2B,4B and 6B pencils.



Fig. 8

Look around to observe the different people at work. Try to make several rough sketches adding different clothing they wear or typical accessories they usually use at work, (for reference see fig. 8A, B, and C). Drawing in Fig. 8 are done with 2B,4B and 6B pencils.

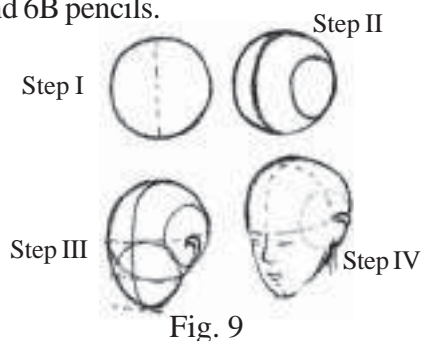

Fig. 9



Fig. 10

Practical Guidelines

(Secondary Level)



Notes



Notes

To construct a head, practice making a circle, divide it in two equal parts, as shown in frame -9 step-I. Extend a circle to its side ways to form ear structure as shown in step-II. Add another circle to form lower jaw and chin as shown in step-III. Divide the plane in three equal parts (line A, B and C) as shown in step-3. Line A becomes the ear line, B the middle line and C the eyebrows. The placement of mouth in between nose and chin and adding eyes can be added later as shown in step-IV. Further observe how the head moves from the side view to front view, for reference see fig. A, B and C as shown in Frame-10.

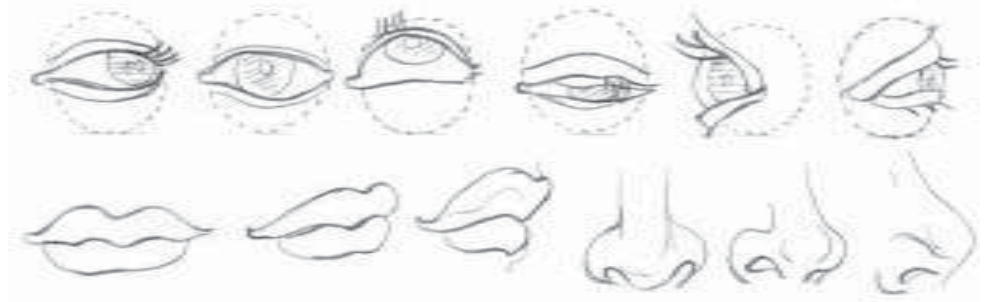

Fig. 11

Locate the basic features to draw a face. Observe the drawing of eyes, lips and nose from different viewpoints (for reference see fig. 9). Drawings in Fig. 11 are made in 2B pencil.



Fig. 12

Observe a smiling face of a girl, from different angle and viewpoints as shown in fig. 12. Adopt these details, while practicing your own studies of a human face. Drawings in fig.10 are done with 2B, 4B, 6B pencils.

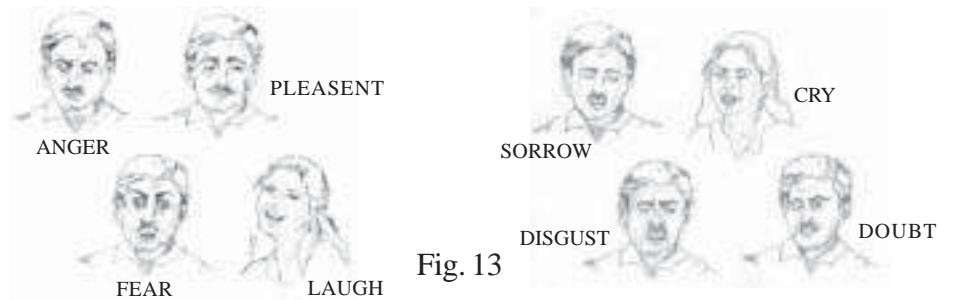

Fig. 13

Human Figure

Relate different moods and expression of human face while studying the above. Observe the changing shapes of eyes and eyebrows, lips to express the feeling of anger (A), pleased (B) fear (C) laugh (D), sorrow (E), cry (F), disgust (G) and doubt (H).

Practical Guidelines

(Secondary Level)



Notes



Fig. 14

Observe the interesting mechanics of movement of a walking human figure, as shown in frame-14 drawn with 2B pencil. Try to create your own walking cycle of figure observing the sketching in Fig. 14.



Fig. 15 A



Fig. 15B

Study the details of portrait with its expression with the help of an appropriate photograph. One may try to do the study; taking reference of his/her own photograph. Moreover working to create a self-portrait is always interesting and achieving. Observe the light and shade in different techniques, like charcoal, pastel, striping or hatching. For reference see Fig. 15A (portrait done in stripling with ink-pen), and Fig. 15B (expression of a child done in hatching and line-drawing with charcoal-pencil).



Fig. 16 and 17



Notes

Do lot of live sketching starting from observing figures at rest or sitting to standing position with different characteristics. Try to capture the basic structure in line-drawing, with 2B or 4B and then add details to it further for reference see fig.-1,2,3 and 4 (Fig.16 and 17).



Fig. 18

Compose five figures. Show each of them is engaged in different activities starting with simple basic structure (see fig. no. 18).



Fig. 19

Arrange these figures according to your imagination. One such option is shown in this composition. After drawing with H.B. pencil the details are finished with ink and brush.



Fig. 20

You may also colour it with any medium of your choice, for reference see fig. 20 (the composition is done in water colour medium).

Exercises

1. Try to sketch your "mother in kitchen" or "father relaxing". First draw the structure in block-drawing as shown in fig. 2. Then add details using HB and 2B pencils.
2. Try to sketch a child of age 10 to 13 years in any posture. Use shading for detail with HB, 2B and 6B pencil.
3. Observe people at work, try to sketch them in different position. Further compose it in to a coloured composition. As shown in fig. 7, fig. 8 and fig. 20.
4. Try to make your own portrait using the help of a photograph as reference. Do the detail shading with the process of stripling or hatching. As shown in fig. 15.

Practical Guidelines

(Secondary Level)



Notes



Notes



Study of a girl (Crayon on bamboo paper)
by Nandlal Bose



Dancer
(Pencil on Paper)
by Nandlal Bose



5

STUDY OF ANIMALS AND BIRDS

AIM

To be acquainted with the animal world of different species around us and know various form colours, textures, movements of different species.

INTRODUCTION

It is one of the most challenging and exciting learning process of dawning painting. Our world is blessed with various kinds of birds and animal species. Each has their own character, form, colour and movements. The stronger animals like tiger, elephant, horse etc. are very interesting to study due to their muscular structures. On the contrary the birds are of lighter structure and very colourful. The study of birds and animals would help the students to understand different ways to handle colour, pen and ink and pencils. For example the heavy animals would require thicker and bolder handling of lines and colours while the birds should be beautifully treated in softer lines and attractive colours. While painting and drawing it should be kept in mind that the structure of human figures are absolute vertical whereas animal and birds are generally have a combination of verticals and horizontal structure.



OBJECTIVE

On completion of this practical exercise, you will be able to:

- study of different birds and animal species around us;
- identify various form, colours, textures and movements of different species;
- draw and paint animal and bird with proportion.

Animal drawing demands the complete application of drawing skill as the surfaces of their bodies provide many textural problem – horns, fur, feathers etc. Choose the animals that you have learned to recognize; horse, cows, dogs, cats and birds of familiar types.



Notes

It is very difficult to draw a bird from live model, as they are being constantly in motion. Better you use your pet bird or photographs of birds of your choice.

Select a common bird and draw its basic structure with geometric shapes.

Circles and egg-shaped forms are arranged to build the structure.

Step I

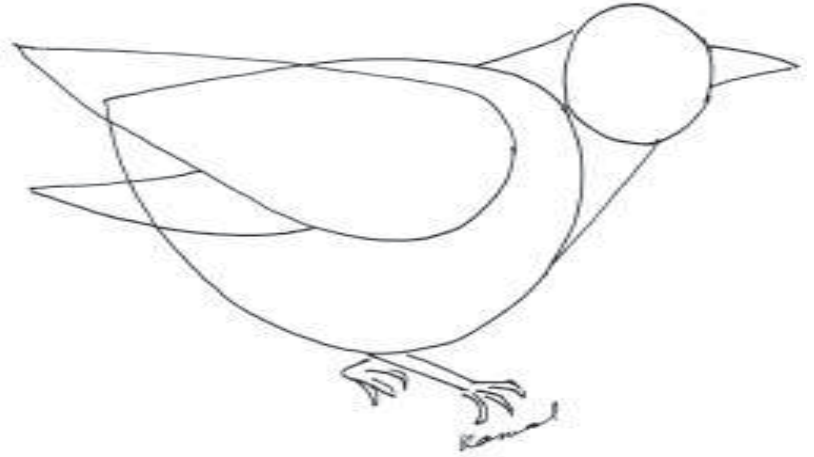

Fig. 1

Draw outlines over this structure and bring out the shape of the bird.

Step II

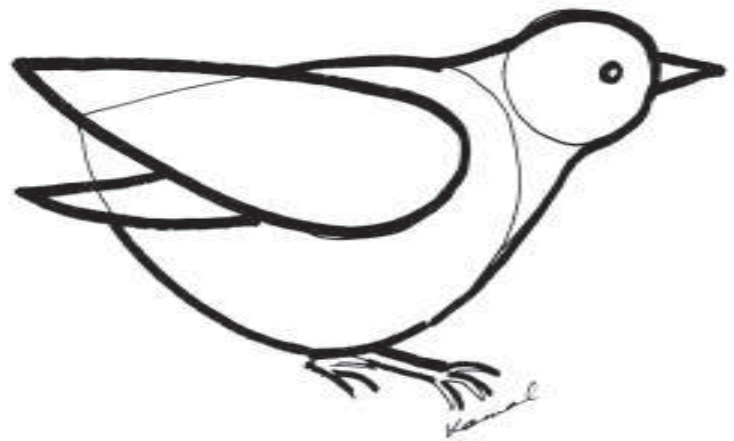

Fig. 2

Use hatching with pen (Gel Black) to give texture of feathers.

Duck is a slow moving bird. Watch it carefully. Basic structure is again egg-shape like most of the birds.

Step III



Fig. 3

Arrange the egg-shaped forms to build the forms of head, neck and torso.

Step I

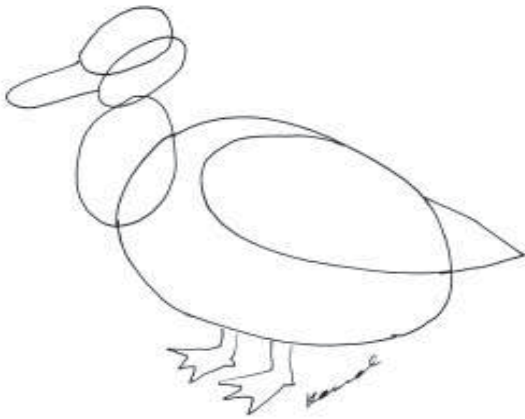

Fig. 4

Draw the outline. Notice the difference of the placement of the shapes from the earlier drawing (Fig. No. 1)

Step II

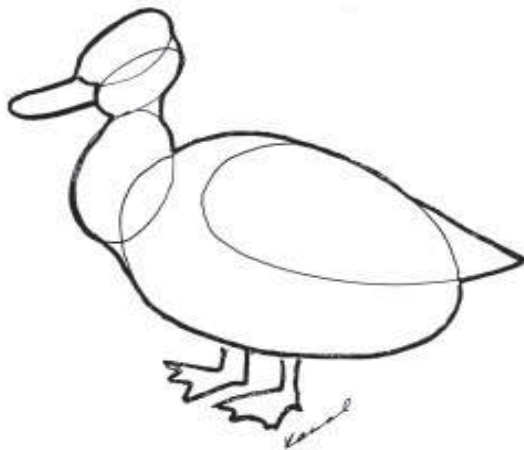

Fig. 5



Notes



Notes

Use colour pencil (green, red, brown, blue and yellow) to complete the drawing.

Step III

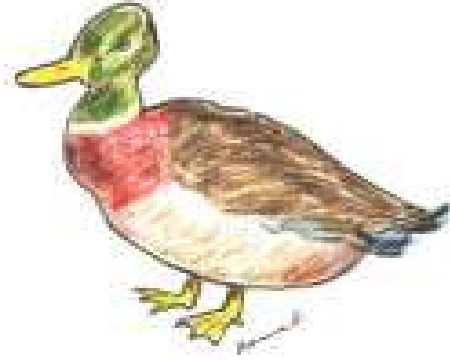

Fig. 6

Our national bird peacock is one of the most colourful birds in the world. Follow the same egg-shape forms for the body except the next, which has long curve lines.

Step I



Fig. 7

Define the outlines as it is shown here.

Step II



Fig. 8

Study of Animals of Birds

Colour the peacock with pastel, (light blue, dark blue, green, yellow and brown). You must have seen lot of hens. Some of them are very colourful Choose one of these hens.

Step III



Fig. 9

Use egg-shape basic forms for all the parts of its body. The torso is also of same shape but only the back side is little flat.

Step I

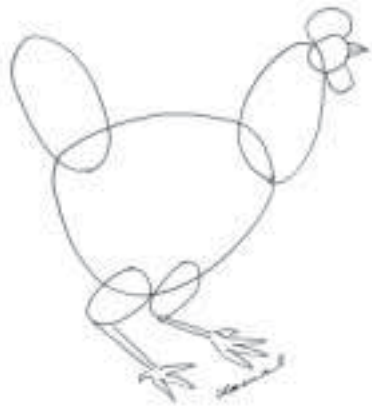

Fig. 10

Draw outline taking care to avoid the front upper leg.

Step II

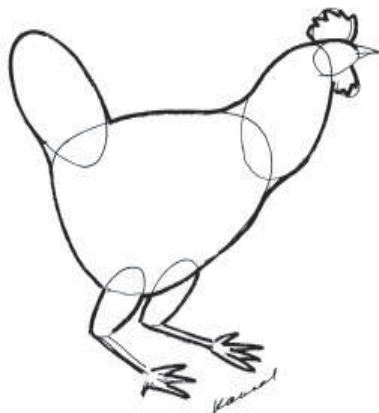

Fig. 11

Practical Guidelines

(Secondary Level)



Notes



Notes

You can use poster colours (red, chrome yellow, burnt sienna, and white) First cover the whole body with red. Let it dry completely. Now use thick colour like chrome yellow and white in small strokes to give the texture of features. Add burnt Sienna in some areas for shading. Cover the legs with yellow.

Step III



Fig. 12

Look at a **Kingfisher** bird. It has proportionately large head and long beak.

Use the egg shape again for the body, head and tail. Two triangles for the beak and the space between body and tail.

Step I

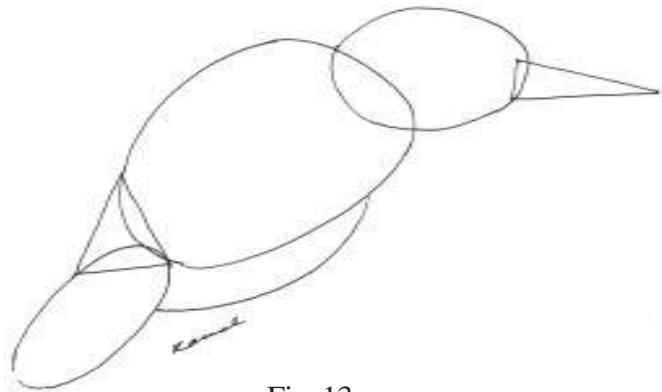

Fig. 13

Draw the outline and then the different forms to give characters of the bird (dot lines)

Step II

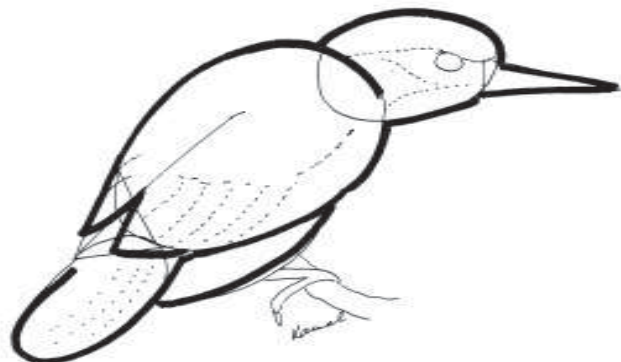

Fig. 14

Study of Animals of Birds

Colour it with transparent water colour (cobalt blue, lemon yellow, Red and black).
Among the animal, dogs are very familiar sight either at home or street.

Step III



Fig. 15

Make line sketch of the dog.

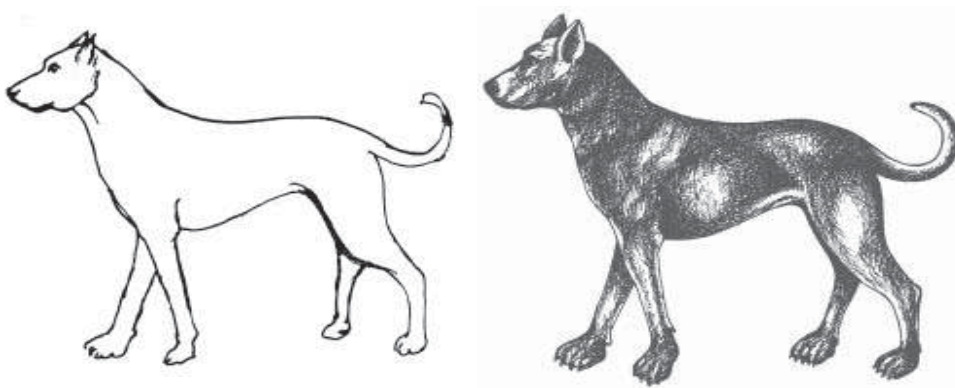

Fig. 16

Use hatching with black gel pen to complete the drawing with light and shade.

Elephant is one of the largest animals with volume. It's basic structure is roundish.

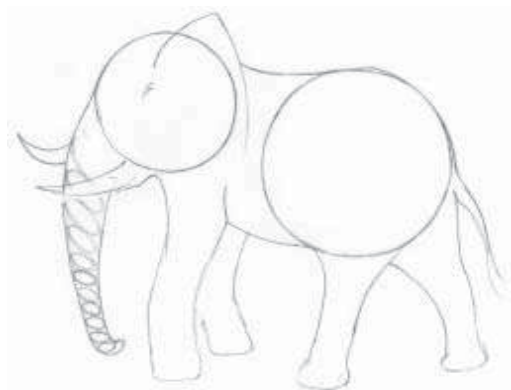

Fig. 17

Practical Guidelines

(Secondary Level)



Notes



Notes

Draw the torso and head with circles. Add four legs and the trunk.

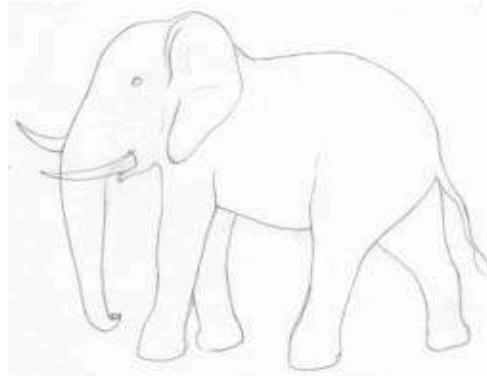

Fig. 18

Colour the drawing with oil pastel colour. Take care to add shades in different parts of the body.

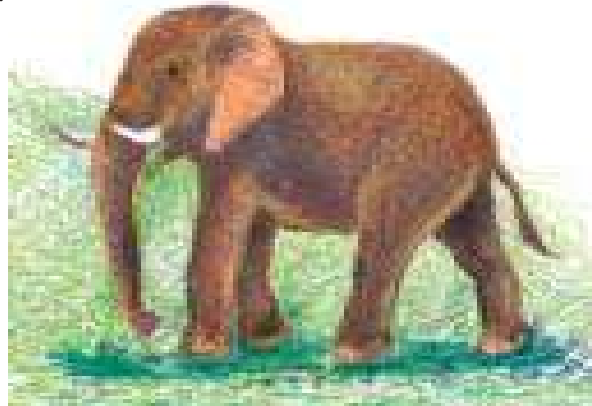

Fig. 19

Note the beautiful pattern on the body of a Giraffe. Capture the image of this animal with 2B pencil.



Fig. 20

Study of Animals of Birds

Tiger is an excellent combination of colour and strength. Use lemon, yellow, brown and crimson water colour. Do not forget to leave paper white for the white areas.



Fig. 21

Exercise

1. Draw the basic structure of a cat using circles and oval shapes.
2. Use colour (pastel or colour pencil) for shading.
3. Observe the basic shapes in birds like, crow, pigeon and hen. Make outlines on these shapes. Colour it with Poster colour.
4. Make a composition with any animals or birds like, cows, pigeons and dogs.
5. Make a copy from some masters painting of Animals or birds.

Practical Guidelines

(Secondary Level)



Notes



Notes

Step - I

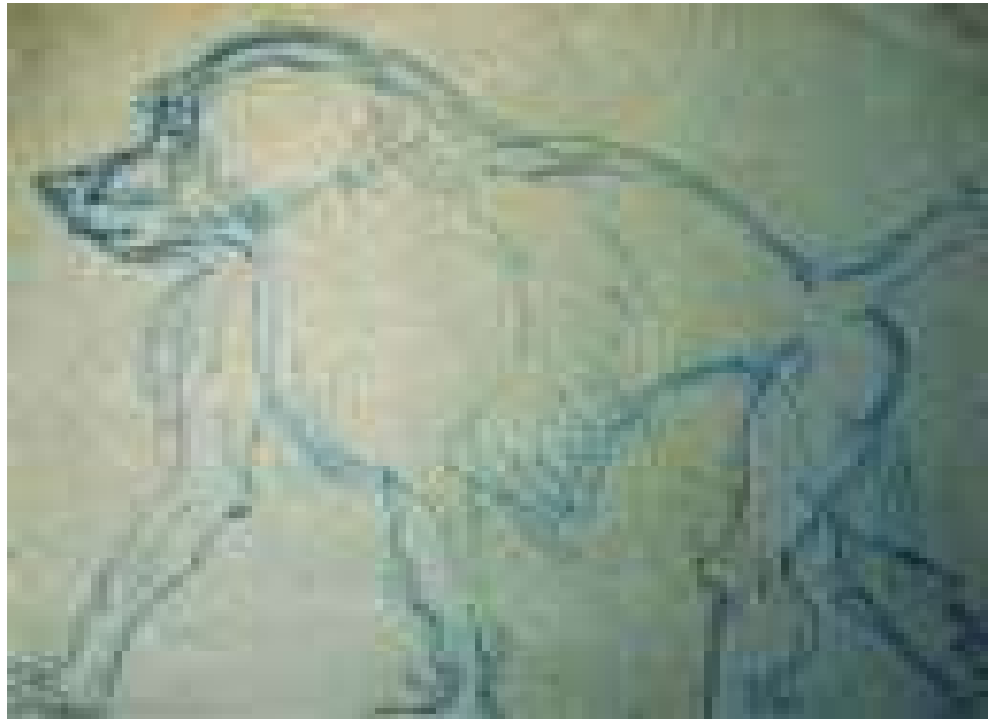

Step - II

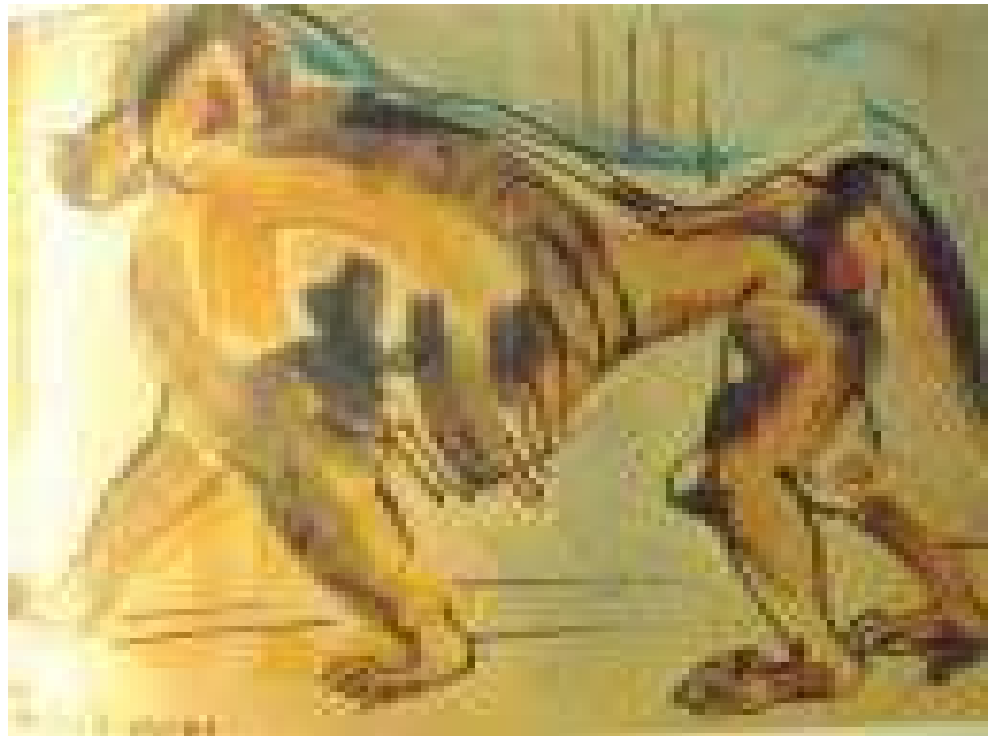

Baboon (Water colour)
by Ramkinkar Baij



6

COMPOSITION

AIM

To compose a picture based on different themes and concept. The concept or theme could be taken from nature, manmade objects and the learners own imagination.

INTRODUCTION

A composition is an arrangement of different elements like, balance, rhythm, harmony and texture in a given space. In spite of all these elements the most important quality is the depiction of expression. One can compose his/her picture with the help of different studies done earlier. Various kinds of composition can be done like:

- I. composition with geometrical forms,
- II. composition with man made objects,
- III. composition based on nature,
- IV. composition with decorative forms,
- V. conceptual composition.

Compositions could be done with all kinds of material available to the learner.

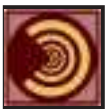

OBJECTIVES

On completion of this Practical exercise, you will be able to :

- differentiate between different kinds of composition;
- select proper material and elements for composition;
- apply forms and colours to express their theme;
- choose the proper colour related to the emotive quality of the composition.



Notes

- Before you compose your picture make sure to arrange it with balance of forms:



Fig. No. 1

This composition is without balance.



Fig. No. 2

Now it becomes balanced after adding another motif.

- Take care to add Rhythm and harmony in your composition. Movement of lines and colours brings rhythm.



Fig. No. 3

Composition

- Texture gives special effect to your picture. Textures are easily achieved in thick use of colours like oil, poster and acrylic.



Fig. No. 4

- Use of perspective is very important in all kinds of realistic drawing. Find the Vanishing point in the composition to determine the line of perspective. On the basis of this structure a composition is made (See Fig. No. 8) in water colour.



Fig. No. 5

- Start composing with simple basic shapes like, square, triangle and circle. Take care of balance, rhythm and harmony. Use only one colour.

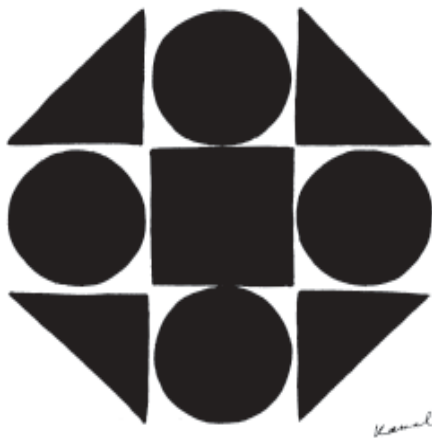

Fig. No. 6

Practical Guidelines

(Secondary Level)



Notes



Notes

- Compose basic shapes and add colours. Do not forget elements of design. Use secondary colours in the overlapping areas.

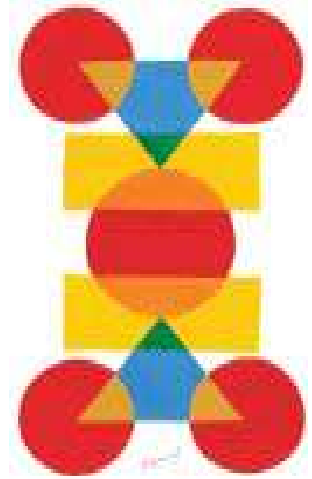

Fig. No. 7

- Now try some complicated compositions with basic shapes. This could look like a conceptual composition.



Fig. No. 8

- Do lot of sketches of human figures. Arrange these figures into a composition. Use water colour.



Fig. No. 9

Composition

These figures are taken from sketches (See lesson No. 1 and Figs. 27 and 29).

- Sketching animals like dogs, cows, horses etc. help to make good composition. Here is a composition with dogs in poster colour. Flat colours are used



Fig. No. 10

- When you Sketch or study man made objects, take care to compose it properly as it is done in this picture.



Fig. No. 11

Practical Guidelines

(Secondary Level)



Notes



Notes

- You must have done many sketches from nature. Choose a spot with lot of trees and make a composition. This is a step for landscape painting.

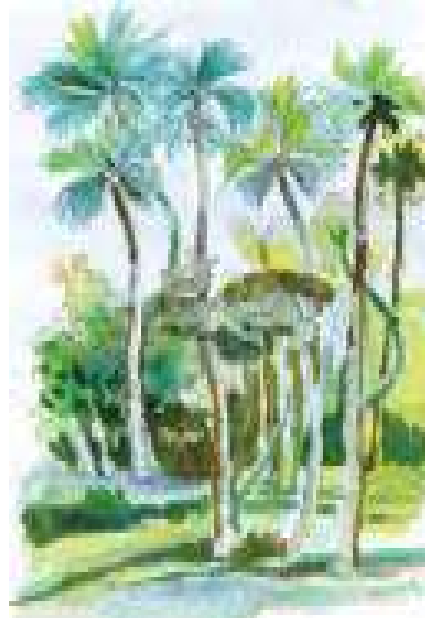

Fig. No. 12

- It is not always possible to find a beautiful place with trees, plants and flowers in a city. Do not worry. You look around and choose a corner of narrow lane or a road side tea shop of anything you like. This could be a good subject for your landscape painting. Water colours material are easy to carry along while for oil painting kits you have to carry many accessories.



Fig. No. 13

Composition

- If you are lucky to visit hill station or sea beach, paint the beautiful scene on canvas with oil colours. Other option is to use photograph as model. In oil medium you can correct and change many time if there is any mistake. This is not possible in the case of water colour.



Fig. No. 14

- Decorative composition could be done with any motifs from your sketches. You can arrange the forms of plants, flowers, birds anything like designs. This is done in coloured inks and black pen.

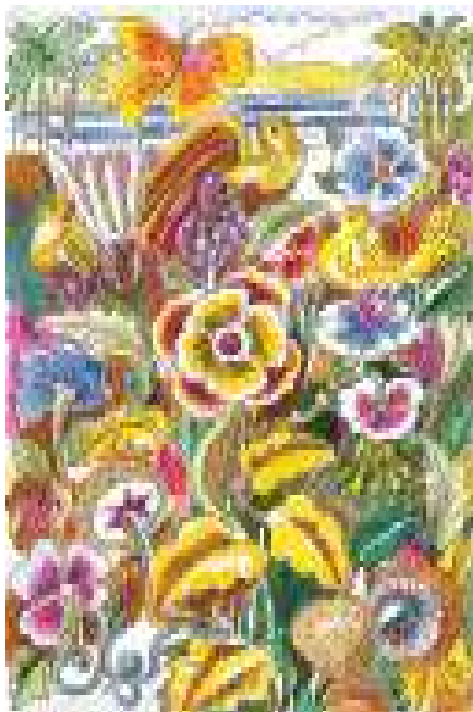

Fig. No. 15

Practical Guidelines

(Secondary Level)



Notes



Notes

- Sometime artists express a concept through their paintings instead of a story or scene. They use forms and colours as symbols which are always not identifiable. So conceptual painting some time becomes abstract or non-representational. The sun, the skeleton of fish and other motifs are used as symbols.



Composition with Forms
Fig. No. 16

Exercises

1. Compose basic shapes (square, triangle and circle) within a paper of A4 or ¼ imperial size. Make sure to create a beautiful design.
2. Select few human figures from your sketch book. Decide on a theme (market, indoor scene, working men or women etc). Make a composition with poster colour.
3. Observe nature around you. Trees plants river, ponds, etc. are the elements you can sketch and make a landscape with water colour.
4. Combine man-made objects, human figures, animal figures in one composition.
5. Make a composition from your memory and imagination on any theme. Try to give it a decorative look.

Practical Guidelines

(Secondary Level)



Notes



Notes



Deer and fawn (Ink on paper)
by N.S. Bendre

PAINTING

SAMPLE QUESTION PAPER DESIGN

Subject : Painting
Theory : 30

Class: Secondary
Practical : 70

<i>Objectives</i>	<i>Marks</i>	<i>Percentage of Total Marks</i>
Knowledge	10	35%
Understanding	15	50%
Application	5	15%
Total	30	100%

WEIGHTAGE BY TYPES OF QUESTIONS

Types of question	No. of questions	Marks of each question	Estimated time a candidate is expected
Long Answer type	3	(3x3) 9/9 min.	27 Ms
Short Answer	7	(2x7) 4/6 min.	42 Ms
Very short answer	7	(1x7) 7/3 min	21 Ms
	17	30	90 Ms

<i>Module</i>	<i>No. of Questions</i>	<i>Marks</i>	<i>Total Marks</i>
1. Introduction of Indian Art			
● Lesson -1	2	2	$2 \times 2 = 4$
● Lesson – 2	1	1	$1 \times 1 = 1$
● Lesson – 3	1	3	$1 \times 3 = 3$
● Lesson – 4	3	1	$3 \times 1 = 3$
2. Introduction of World Art			
● Lesson – 5	1	3	$1 \times 3 = 3$
● Lesson -6	3	2	$3 \times 2 = 6$
● Lesson – 7	3	1	$3 \times 1 = 3$
3. Introduction of Contemporary Indian Art			
● Lesson – 8	1	3	$1 \times 3 = 3$
● Lesson – 9	2	2	$2 \times 2 = 4$
			Total 30

DIFFICULTY LEVEL OF QUESTION PAPER

<i>Level</i>	<i>No</i>	<i>%age of Marks given</i>
<ul style="list-style-type: none">● Difficult (can be attempted by top students)● Average (can be attempted by students who have regularly studied the materials but may not have given sufficient time to writing practice)● Easy (can be attempted satisfactorily by students who have gone through the study materials)		20%
		50%
		30%
		100%

SAMPLE QUESTION PAPER

Time : 1 ½ hours

Marks : 30

Attempt all questions

- The question having 1 mark should be answered in about **10 words**
 - The question having 2 marks should be answered in about **30 words**.
 - The question having 3 marks should be answered in about **50 words**.
1. Describe the “**Dancing Girl**”, metal Sculpture and mention its finding site. 2
 2. Choose a painting from Ajanta and appreciate its style and technique. 2
 3. Write very short note on any one of the following. 1
 - a. “Arjunas Penance”
 - b. “Konark”
 - c. Krishna supporting Mount Govardhan
 4. How did Rajput painting develop? What are the contributions of “Guler School” in its development? 3
 5. What is Kolam? What kinds of symbolic forms are used in it? 1
 6. What is the meaning of Phulkari? Write few lines on Phulkari design. 1
 7. Mention the motifs and designs of ‘Kantha’ art.
 8. Assess the role of Renaissance in formulation of new forms of painting style. How did it affect the painters like Botticelli and Leonardo da Vinci. 3

or

Do you consider Michelangelo as the greatest sculptor of Renaissance? Justify your answer.

9. Write about the main features of Impressionist Painting. 2
10. What were Renoir's preferences in choosing the themes of his paintings. Explain with example. 2
11. Write two important features of Cezanne's painting “Still Life with Onions”. 2

12. What is 'Cubism'? Who are the artists to begin this style? 1
13. Why Salvador Dali is so famous? Name one of his famous paintings. 1
14. Write notes on any one of the following. 1
- a. Kandinsky
 - b. "Man with violin"
 - c. Abstract Art.
15. Answer any one of the following questions. 3
- a. Write in brief on the kind of art evolved in the beginning of British Raj in India.
 - b. Write an appreciative note on Gaganendranath Tagore.
- 16 What is Graphics or Print Making? Name some of the print making techniques. 2
- 17 "Neither his poor eyesight in young age and blindness in later age could stop his creative urge."
Who is this painter? Describe one of his paintings. 2

MARKING SCHEME

Subject – Painting

<i>Q.No.</i>	<i>Expected answer</i>	<i>Distribution of Marks</i>	<i>Total Marks</i>
1.	<p>This beautiful female metal statue was found in Indus valley. It's curious posture is noticeable.</p> <p>The figure shows the artist's accurate metal casting with her right hand at her waist and her left hand on her left thigh. The craftsmanship and artistic skill has been blended successfully.</p>	<p>½</p> <p>1½</p>	2
2.	<p>“Black Princess” of Gupta period was found in one of the caves of Ajanta near Aurangabad.</p> <p>This lyrical painting made of tempera technique shows the free flowing line and rhythm of the body contour.</p>	<p>½</p> <p>1½</p>	2
3.	<p>a. From Pallava Period at Mamallapuram. On a huge boulder relief sculpture identified as the story of “Arjuna’s Penance” and according to some others "Gangavatarana".</p> <p style="text-align: center;">or</p> <p>b. The sun temple at Konark, Orissa. Beautiful Sulputers of Surasundaris are carved.</p> <p style="text-align: center;">or</p> <p>c. This sculpture is from Hoysala period at Belur. The carvings are delicate and intricate.</p>	<p>1</p> <p>1</p> <p>1</p>	1
4.	<p>After the fall of many dynasties, a form of art developed in the western part of India in Rajasthan and Punjab hills. This is known as Rajput painting. Rajput paintings flourished from the 16th Century A.D. to 19th Century A.D. This style is</p>	<p>1½</p>	3

<i>Q.No.</i>	<i>Expected answer</i>	<i>Distribution Marks</i>	<i>Total Marks</i>
	<p>a combination of folk and classical paintings of India. Later it was influenced by Mughal miniature painting.</p> <p>Guler was a small State in the hills of Punjab and a most important centre of Pahari painting. The style flourished between 1450 A.D. to 1780 A.D. It is characterized by Romance and myth of Radhakrishna.</p>	1½	
5.	<p>“Kolam” is floor decoration with Rice paste. It is painted on the floor by House wife during festivals with symbolic forms like pitchers, lamps and coconut trees.</p>	1	1
6	<p>It means “flowered work.” This term is used for a type of embroidery in Punjab.</p> <p>Basic motifs are geometric</p>	½	1
7.	<p>Motifs and designs are taken from rural landscape, ritualistic mandala and objects of everyday life.</p>	1	1
8.	<p>Renaissance is a word which means “Rebirth”. This period is known for new experiments in every field, including the art of painting and sculpture.</p> <p>Through 14th C.A.D to 18th C.A.D experiments on use of light, shadow, foreshortening and perspective were carried by great masters like Leonardo Da Vinci, Raphael, Botlicelli, Michel Angelo. Botlicelli showed skill in the drawing of anatomy in his own style. He used cool artificial light to achieve soft harmonious beauty in his work. On the other hand, Vinci experimented with dramatic contrast of light and shade.</p> <p>He gave emphasis on the psychological aspect of expression, for example “Monalisa”.</p> <p style="text-align: center;">OR</p>	½	3
		2½	

<i>Q.No.</i>	<i>Expected answer</i>	<i>Distribution Marks</i>	<i>Total Marks</i>
	Michel Angelo is definitely the greatest sculptor of Renaissance period. He was a master in handling marble. One of his master pieces is “Pieta”. It is the most highly finished work of Michel Angelo. The sculpture has unique drapery movement and strong anatomy details.	2½	
	His other famous works, 'Moses,' 'David' etc. are enough to regard him as the great master.	½	
9.	Impressionism was an artistic movement. The exhibition was held in 1874. The painters followed a style concerned with effect of life and colours.	1	2
	It came to represent a great change between classical and modern painting. The pioneers of this style are Monet, Renoir and Dega.	1	
10.	Renoir was a French Impressionist artist. He painted mainly sentimental and charming paintings. He preferred to paint group composition, portraits and female model studies.	1	2
	He used shades of purple, white and blue tones to unite modelling of figures, dressed in fashionable clothes in the painting like “Moulin de-la Galette.”	1	
11.	Cazenne was a post impressionist painter who emphasized on expression. He showed simplification of forms.	½	2
	In his painting “Still Life with Onions” he used plain colour strokes. Composition shows vertical and horizontal breaks with arrangement of three dimensional space.	1½	
12.	Cubism the a style of painting and sculpture in which everthing in nature is treated as cylinder and sphere.	1	1
13.	Dali is famous for surrealist painting. He used his paintings to depict the world of absurd and unusual strange elements.	1	1

<i>Q.No.</i>	<i>Expected answer</i>	<i>Distribution Marks</i>	<i>Total Marks</i>
14.	(a) Kandinsky is pioneer of abstract painting. His works are combination of abstract and geometric.	1	1
	(b) This cubist painting is done by Picasso. It is a fine example of analytical cubism.	1	
	(c) Abstract art is a general term of non-representational art, which rejects depiction of contemporary world in a realistic way.	1	
15.	At the beginning of British Raj, Indian art displayed general decline. Fresco painting, miniature painting ceased to exist. Indian artist started to follow European style and technique of art with oil and water colour medium. Raja Ravi Verma painted Indian themes from Mythology and Epics. Abanindranath invented his personal style of Bengal school. Rabindranath brought abstraction and introduced post impressionist style. Jamini Roy gave a sophisticated form to Folk Art. OR Gaganendranath was a leading figure in Contemporary Indian art. He showed inclination towards cubism, but developed individual style with abstract geometric structure. He was also a great critic of his time and his social cartoons were popular. One of his paintings “Atrium” is a remarkable work of Cubist influence.	1½ 1½ 1½	3
16.	Graphics is a process of multiplying pictures through printing. There are different kinds of print making technique viz. Etching, Dry point, aquatint, intaglio, lithography, oliography, silk screen etc.	½ 1½	2

<i>Q.No.</i>	<i>Expected answer</i>	<i>Distribution Marks</i>	<i>Total Marks</i>
17.	<p>Benode Behari Mukherjee was the artist, who kept on creating in spite of his blindness.</p> <p>He created a huge mural at Kala Bhavan, Santiniketan, in West Bengal, after he became completely blind.</p>	<p>1</p> <p>1</p>	2